SECTION 1

SERVICE MANUAL

TABLE OF CONTENTS

I. SPECIFICATIONS	2
II. DISMANTLING OF UNIT	4
III. ARRANGEMENT OF PRINCIPAL PARTS	5
IV. FM TUNER SECTION ADJUSTMENTS	6
V. AM TUNER SECTION ADJUSTMENT (Model AA-1020)	10
VI. AM (LW AND MW) TUNER SECTION ADJUSTMENT (Model AA-1020L)	11
1. LW SECTION ADJUSTMENT	11
2. MW SECTION ADJUSTMENT	11
VII. MAIN AMPLIFIER ADJUSTMENT	12
VIII. TUNING CORD THREADING	13
IX. CLASSIFICATION OF VARIOUS P.C BOARDS	14
1. P.C BOARD INTERCHANGEABILITY CHART	14
2. COMPOSITION OF VARIOUS P.C BOARDS	15

For basic adjustments, measuring methods, and operating principles, refer to GENERAL OPERATING PRINCIPLES AND ADJUSTMENTS.

I. SPECIFICATIONS

An asterisk next to a figure indicates the minimum guaranteed performance.

1. AMPLIFIER SECTION (Models AA-1020 and AA-1020L)

RATED OUTPUT		20 watts per channel (both channels driven). Minimum RMS, at 8 ohms load impedance from 20 to 20,000 Hz, with on more than 0.4% total harmonic distortion.
POWER BAND WIDTH (IHF)		10 to 60 kHz at 8 ohms, distortion within 0.4%.
INPUT SENSITIVITY	PHONO-1, 2 TAPE-1, 2 AUX	3 mV/50 k ohms (-48 ± 1.5 dBm) with output 24.3 dBm, 8 ohms as standard. 150 mV/80 k ohms (-14 ± 1.5 dBm) with output 24.3 dBm, 8 ohms as standard. 150 mV/80 k ohms (-14 ± 1.5 dBm) with output 24.3 dBm, 8 ohms as standard.
RESIDUAL NOISE		Less than 1.4 mV (Less than -55 dBm)
SIGNAL TO NOISE RATIO (IHF)	PHONO-1, 2 TAPE-1, 2 AUX	Better than 80 dB (Less than -40 dBm, input shorted) Better than 90 dB (Less than -50 dBm, input open) Better than 90 dB (Less than -50 dBm, input shunted at 5 k ohms)
TONE CONTROL	BASS TREBLE	10 ± 1.5 dB, -10 ± 1.5 dB at 100 Hz 10 ± 1.5 dB, -10 ± 1.5 dB at 10 kHz
LOUDNESS CONTROL		10 ± 1.5 dB at 100 Hz 6 ± 1.5 dB at 10 kHz
FILTER	LOW CUT HIGH CUT	-6 dB at 50 Hz * -8 ± 1.5 dB at 50 Hz -9 dB at 10 kHz * -9 ± 1.5 dB at 10 kHz
FREQUENCY RESPONSE (PHONO)		RIAA ± 1 dB * 13.11 ± 1.0 dB at 100 Hz * -13.75 ± 1.0 dB at 10 kHz
CHANNEL SEPARATION (IHF)		Better than 55 dB at 1,000 Hz *Better than 50 dB at 1,000 Hz
CROSS TALK (PHONO)		Better than 50 dB
L-R DEVIATION (PHONO)		Within 3 dB
RECORDING OUTPUT (PHONO)	PIN DIN	150 mV (-14.3 ± 2 dBm) 26 mV (-28.2 ± 2 dBm)

2. FM TUNER SECTION (Models AA-1020 and AA-1020L)

FREQUENCY RANGE		88 to 108 MHz *87.4 to 109 ± 1 MHz
DIAL TRACKING ERROR		± 250 kHz
SENSITIVITY (IHF)		2.0 μ V *Less than 3.2 μ V (10 dB)
SENSITIVITY DEVIATION		Within 3 dB
IMAGE REJECTION RATIO		Better than 65 dB at 98 MHz *Better than 50 dB (IHF)
IF REJECTION RATIO		Better than 90 dB at 98 MHz *Better than 80 dB (IHF)
CAPTURE RATIO (IHF)		Less than 2 dB
LIMITING SENSITIVITY		Less than 8 dB (Audio output -1 dB)
MUTING SENSITIVITY		15 to 30 dB
SELECTIVITY (IHF)		Better than 70 dB *Better than 65 dB
AM SUPPRESSION RATIO		Better than 45 dB
SIGNAL TO NOISE RATIO		Better than 68 dB *Better than 50 dB (STEREO) including carrier leak *Better than 60 dB (MONO)
DISTORTION FACTOR		Less than 0.5% (STEREO) *Less than 1.0% (STEREO) Less than 0.3% (MONO) *Less than 0.5% (MONO)
FREQUENCY RESPONSE		-13 ± 1 dB at 10 kHz (US-A) -10.5 ± 1 dB at 10 kHz (US-B)
STEREO SENSITIVITY		4.5 μ V (15 ± 3 dB)
STEREO SEPARATION		Better than 40 dB
L-R DEVIATION		Within 3 dB
RECORDING OUTPUT	PIN DIN	390 mV (-6 ± 3 dBm) 70 mV (-21 ± 3 dBm)

3. AM, MW TUNER SECTION (Models AA-1020 and AA-1020L)

FREQUENCY RANGE	535 to 1,605 kHz *500 to 1,650 kHz	
DIAL TRACKING ERROR	Within 2%	
SENSITIVITY (IHF)	200 μ V/m (Bar antenna) 5 μ V/m (Ext antenna) *320 μ V/m (Bar antenna)	
SENSITIVITY DEVIATION	Within 6 dB	
IMAGE REJECTION RATIO	Better than 50 dB at 1 MHz	
IF REJECTION RATIO	Better than 45 dB at 1 MHz *Better than 50 dB at 1 MHz	
SELECTIVITY	Better than 30 dB \pm 10 kHz	
SIGNAL TO NOISE RATIO	Better than 50 dB *Better than 45 dB	
DISTORTION FACTOR	Less than 0.8% *Less than 1.5%	
FREQUENCY RESPONSE	-15 dB at 3 kHz	
RECORDING OUTPUT	PIN	270 mV (-9 \pm 2 dBm)
	DIN	55 mV (-23 \pm 2 dBm)

4. AM, LW TUNER SECTION (Model AA-1020L only)

FREQUENCY RANGE	150 to 350 kHz	
DIAL TRACKING ERROR	Within 2%	
SENSITIVITY (IHF)	1 mV/m (Bar antenna) 15 μ V (Ext antenna)	
IMAGE REJECTION RATIO	Better than 30 dB at 240 kHz	
IF REJECTION RATIO	Better than 30 dB at 240 kHz	
SELECTIVITY (IHF)	Better than 30 dB \pm 10 kHz	
SIGNAL TO NOISE RATIO	Better than 35 dB	
DISTORTION FACTOR	Less than 3%	
RECORDING OUTPUT	PIN	155 mV (-14 \pm 2 dBm)
	DIN	35 mV (-27 \pm 2 dBm)

5. GENERAL (Models AA-1020 and AA-1020L)

TRANSISTOR	2SA661(O)(Y) ... 2	2SC1166(O)(Y) ... 2
	2SA733(Q)(R) ... 1	2SC1222(E)(F) ... 10
	2SC536(E)(F) ... 1	2SC1449(K)(L) ... 1
	2SC930(E)(F) ... 1	2SD371(O)(R) ... 4
	2SC945L(K)(P) ... 4	2SD571(L)(M) ... 1
IC	μ PC30C ... 1	LA3350A ... 1
	LA1230 ... 1	
DIODE	10D1 ... 2	1S2473 ... 2
	1R5BZ61 ... 4	VD1222 ... 6
	WZ130 ... 1	SEL102R ... 2
POWER REQUIREMENTS	110 Volts/220 Volts/240 Volts, 50/60 Hz, Switchable 120 Volts, 60 Hz CSA 220 Volts, 50 Hz CEE	
DIMENSIONS	440(W) x 140(H) x 350(D) mm (17.3" x 5.5" x 13.8") (Dimensions include all protruding parts)	
WEIGHT	12 kg (26.4 lbs.)	

NOTE: Specifications subject to change without notice.

II. DISMANTLING OF UNIT

In case of trouble, etc. necessitating disassembly, please disassemble in the order shown in photographs. Reassemble in reverse order.

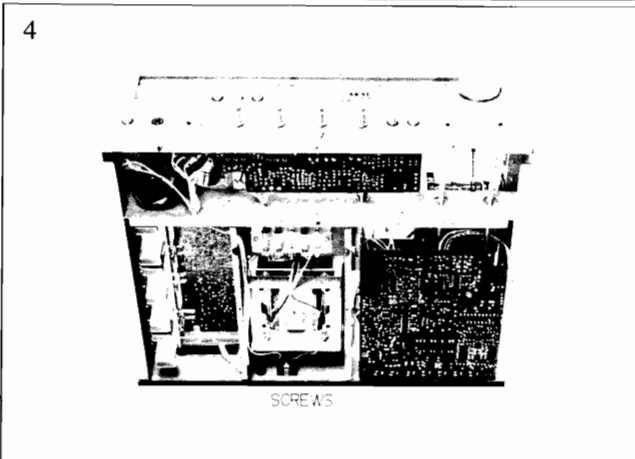
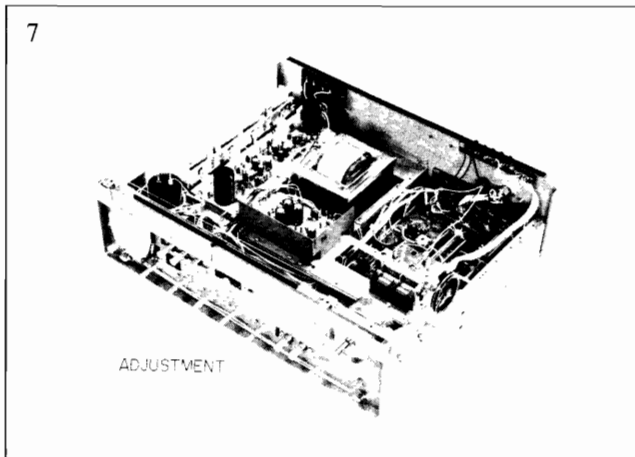
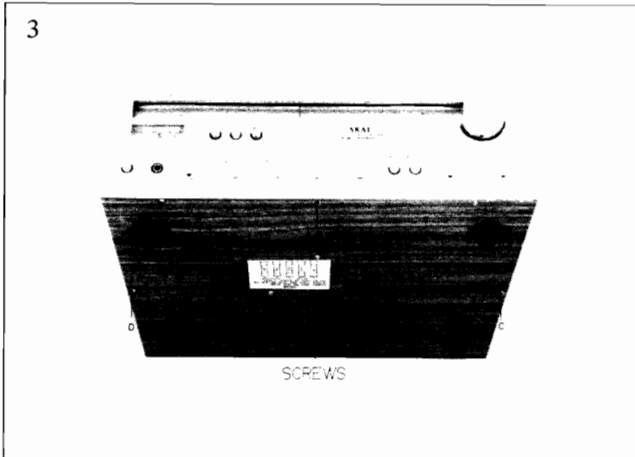
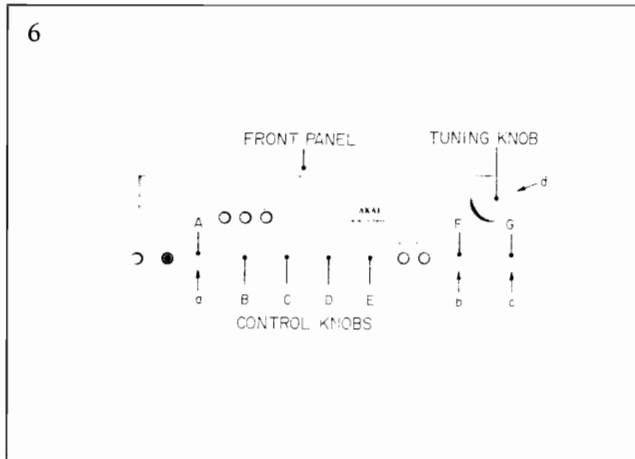
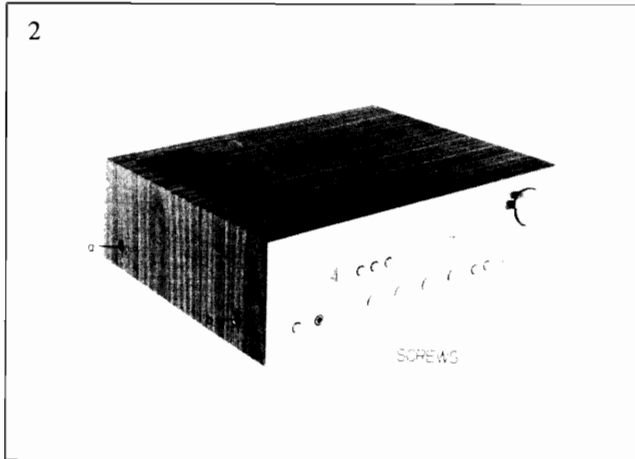
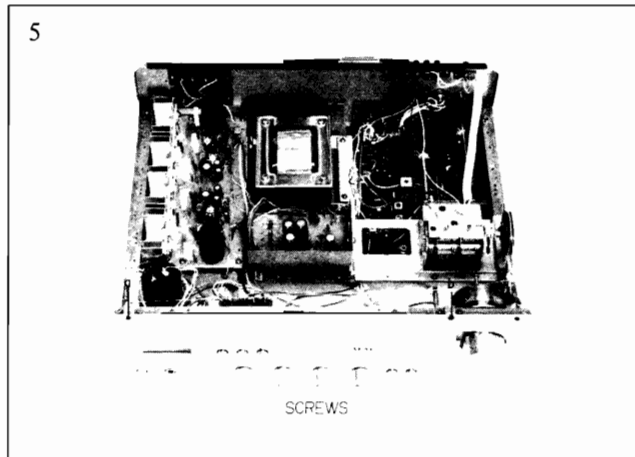
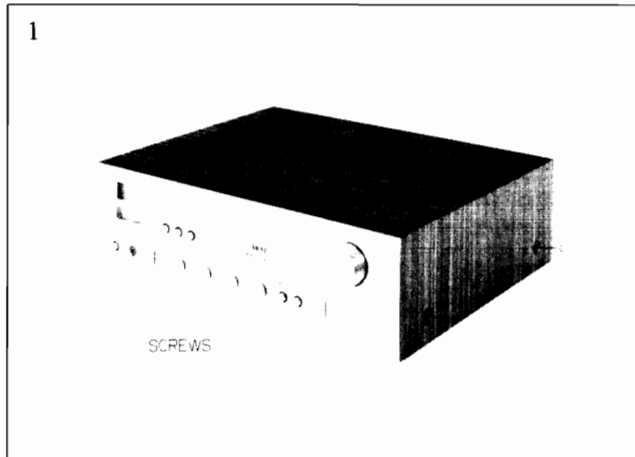

III. ARRANGEMENT OF PRINCIPAL PARTS

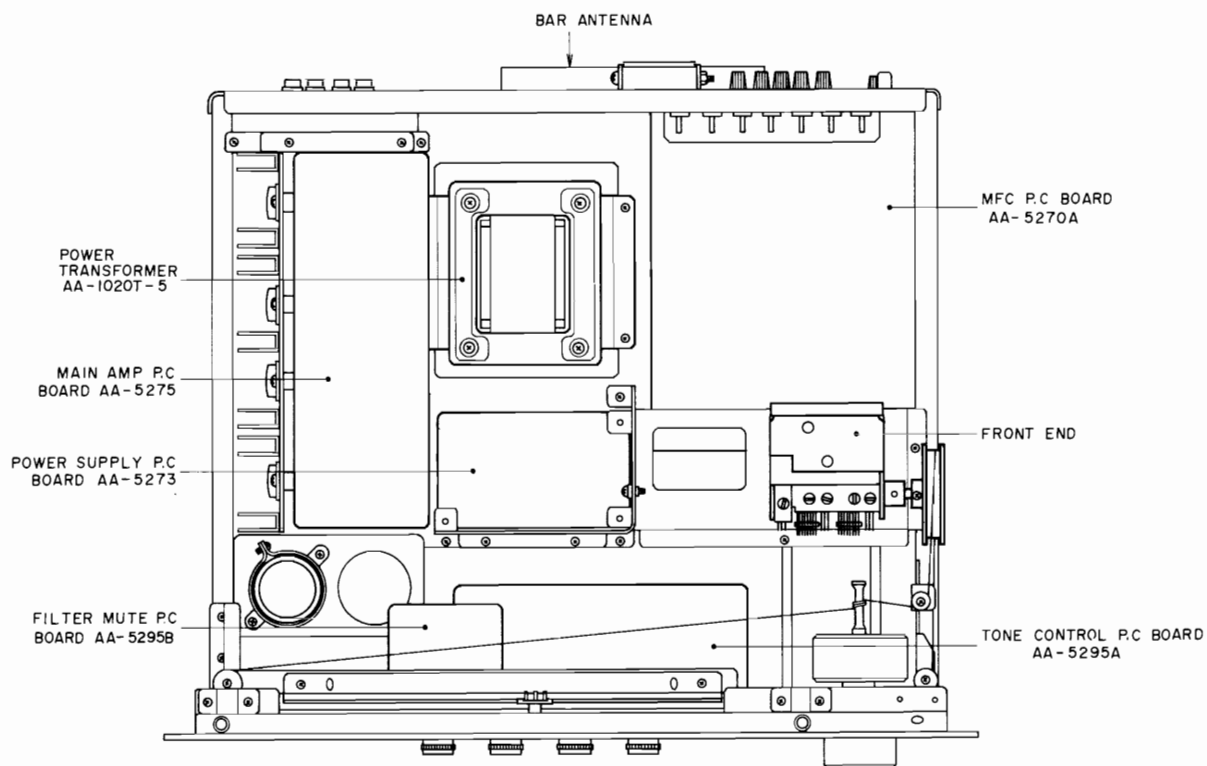

TOP VIEW

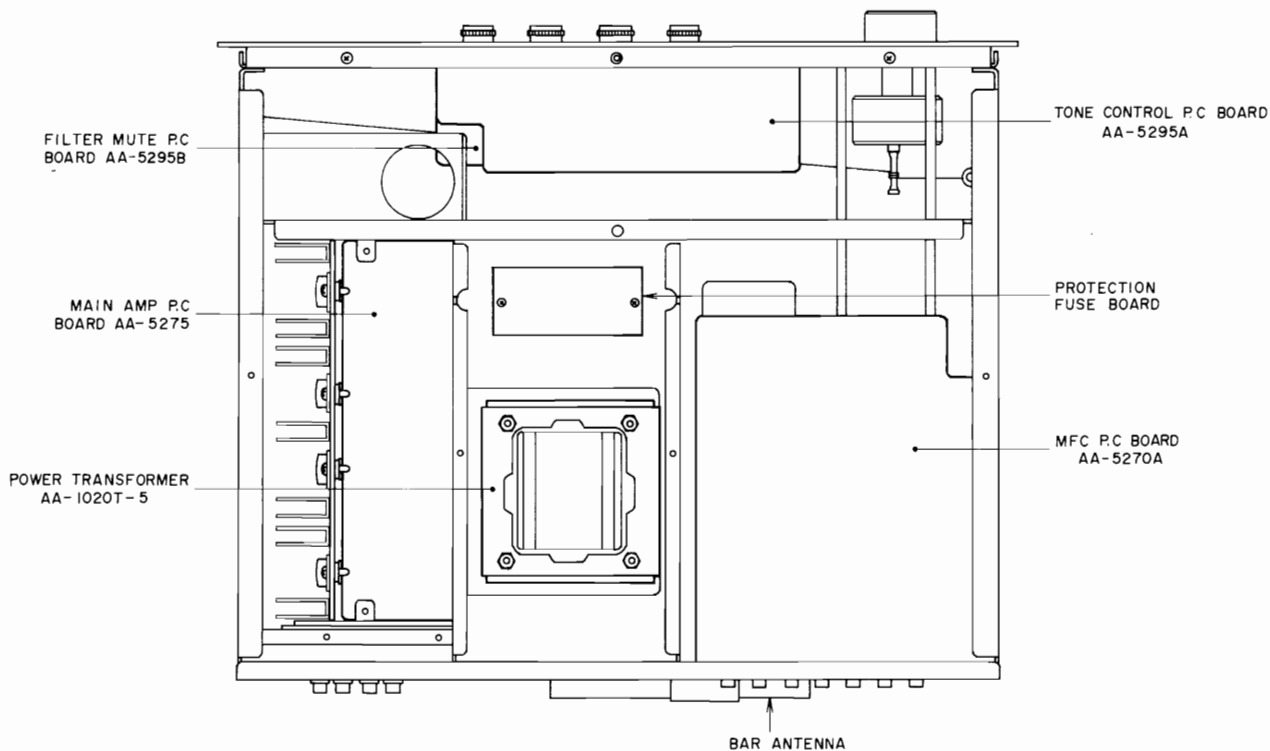

BOTTOM VIEW

IV. FM TUNER SECTION ADJUSTMENTS

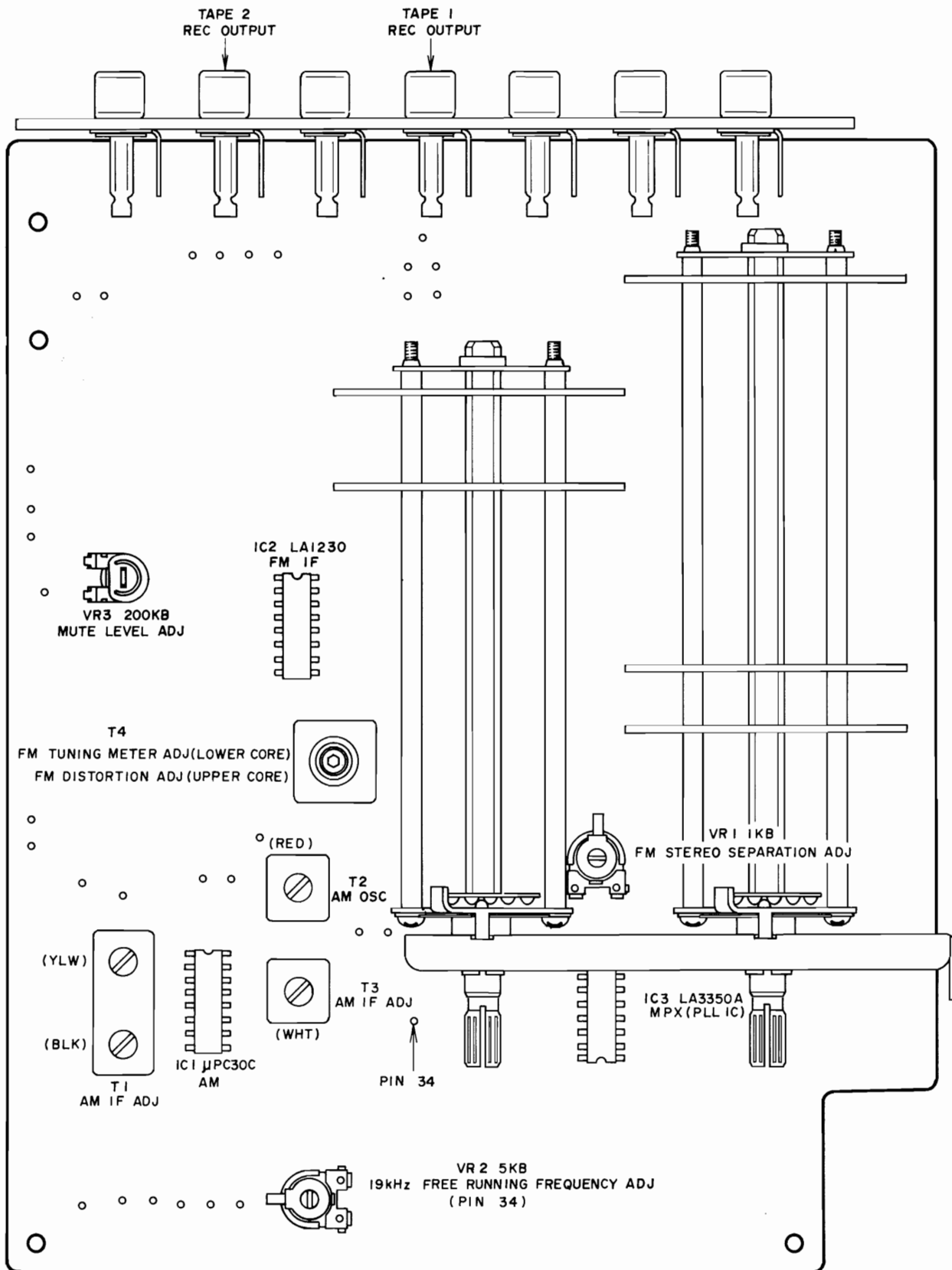

Fig. 1 MFC P.C Board AA-5270A (AA-1020)

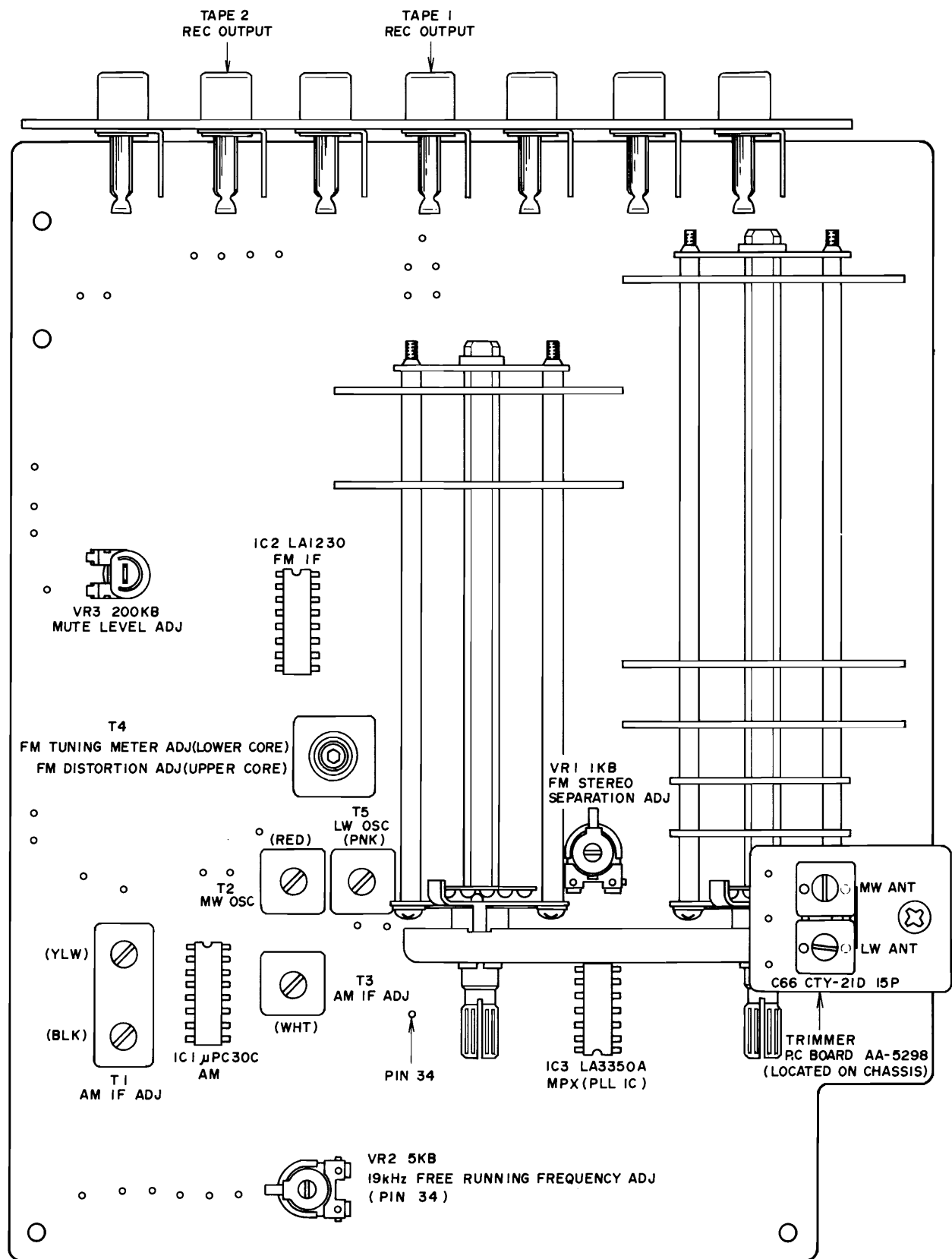

Fig. 2 MFC P.C Board AA-5270A (AA-1020L)

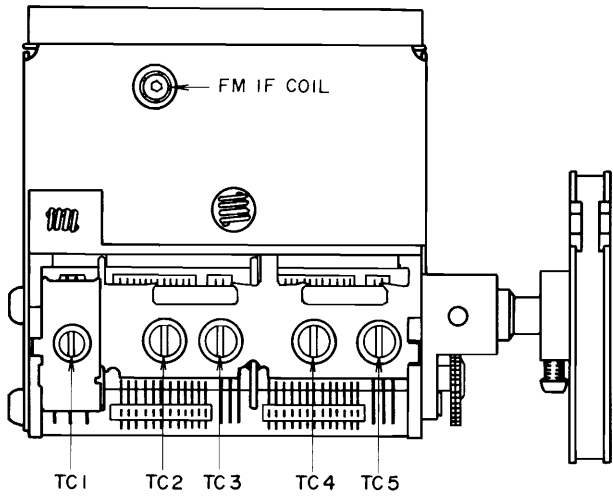

Fig. 3 Front End (AA-1020)

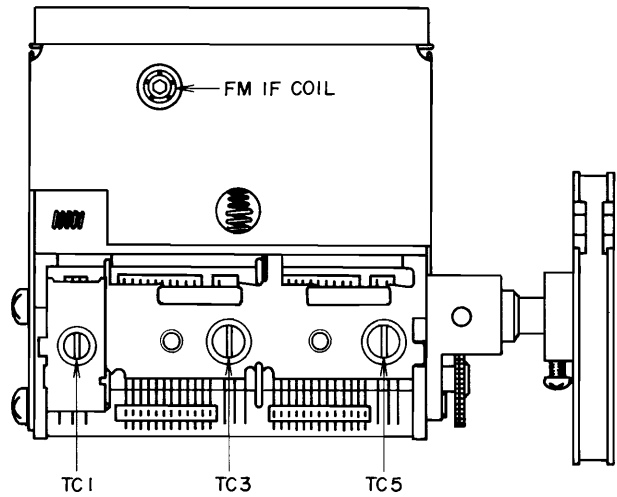

Fig. 4 Front End (AA-1020L)

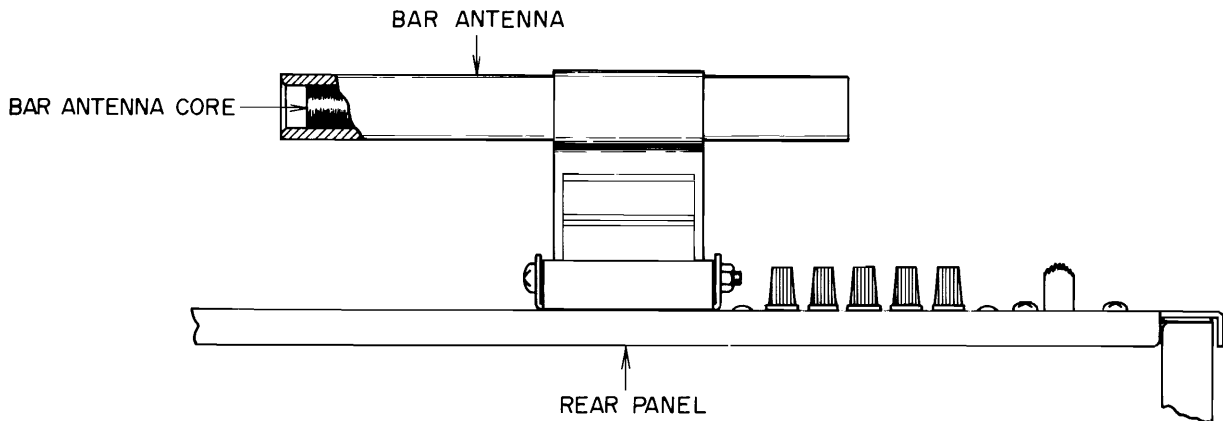

Fig. 5 Model AA-1020

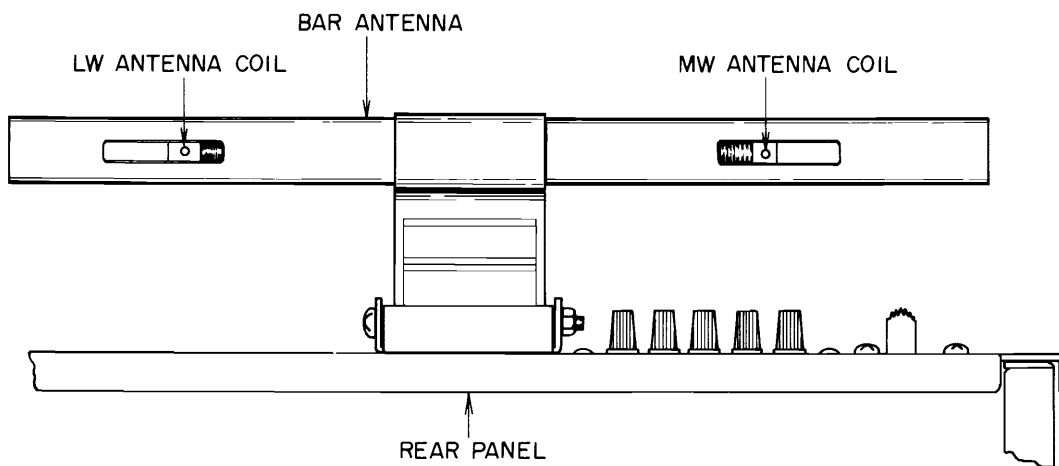

Fig. 6 Model AA-1020L

Step	Adjustment Item	Adjustment Point	Result	Remarks
1	Front End IF Coil Adjustment	IF Coil (Front End)	Maximum noise level	SELECTOR to "FM AUTO" Tune only noise without interference of broadcasting (See Fig. 3)
2	Tuning Meter Centering	T-4 Lower Side Core (MFC P.C Board)	Center Indication of Tuning Meter	Same as above (See Fig. 1)
3	Distortion Factor Adjustment	T-4 Upper Side Core (MFC P.C Board)	Less than 0.4% Distortion Factor	108 MHz, 60 dB (mono) input. Less than 0.4% on both channels (See Fig. 1)
4	Confirmation of Tuning Meter Indication			If Tuning Meter indication is not at center position, re-adjust STEPS 2 & 3 above.
5	Frequency Coverage Adjustment	TC-1 (Front End)		108 MHz, 60 dB (mono) input. Error: within ± 250 kHz (See Fig. 3)
6	Sensitivity Adjustment	TC-3, TC-5 (Front End)	Less than 3% Distortion Factor	108 MHz, Less than 10 dB (mono) input (See Fig. 3)
7	Low Range Sensitivity Confirmation		Less than 3% Distortion Factor	88 MHz, Less than 10 dB (mono) input. Error within ± 250 kHz See NOTE-1
8	Mid Range Sensitivity Confirmation		Less than 3% Distortion Factor	98 MHz, Less than 10 dB (mono) input. See NOTE-1
9	PLL IC Free Running Frequency Adjustment	VR-2 5 kB (MFC P.C Board)	19.00 kHz	Mute Switch "ON", Frequency Counter to PIN-34 (MFC P.C Board) See NOTE-2
10	Stereo Indicator Lighting Confirmation			98 MHz, 60 dB (Stereo) input No lighting of stereo indicator means that stereo broadcasts are not being received.
11	Stereo Separation Adjustment	VR-1 1 kB (MFC P.C Board)	Better than 40 dB	98 MHz, 60 dB (Stereo), L-ch input. Distortion factor must be less than 1.0% (See Fig. 1)
12	Stereo Separation Adjustment		Better than 40 dB	98 MHz, 60 dB (Stereo), R-ch input. Distortion factor must be less than 1.0% and if it exceeds 1.0%, adjust the coil in STEP-1 within a half-turn.
13	FM Mute Level Adjustment	VR-3 200 kB (MFC P.C Board)	20 \pm 3 dB	Mute "ON", 98 MHz (mono) input
14	Confirmation of Tuning Meter Indication		Tuning Meter: Center	

Chart-1

NOTE-1 In the event that the distortion factors in STEP-7 & 8 are not less than 3%, re-adjust Front End Trimmers TC-3 & TC-5 to obtain a minimum average distortion factor at 88, 98 & 108 MHz (same distortion factor at all 3 points).

NOTE-2 Free running frequency of the PLL IC must be an exact 19.00 kHz.

V. AM TUNER SECTION ADJUSTMENT (Model AA-1020)

Step	Adjustment Item	Adjustment Point	Result	Remarks
1	Low Range Frequency Coverage Adjustment	T-2 (RED) (MFC P.C Board)	Tracking error: Less than 2%	520 kHz optional input (See Fig. 1)
2	Sensitivity Adjustment	Bar Antenna Core T-1 (YLW, BLK) T-3 (WHT) (MFC P.C Board)	Maximum Sensitivity	520 kHz optional input (See Fig. 1)
3	High Range Frequency Coverage Adjustment	TC-2 (Front End)	Tracking error: Less than 2%	1,400 kHz optional input (See Fig. 3)
4	Sensitivity Adjustment	TC-4 (Front End)	Maximum Sensitivity	1,400 kHz optional input (See Fig. 3)

NOTE: Repeat procedures in steps from 1 to 4.

Chart-2

VI. AM (LW AND MW) TUNER SECTION ADJUSTMENT (Model AA-1020L)

1. LW SECTION ADJUSTMENT (Refer to Figs. 2,6)

Step	Adjustment Item	Adjustment Point	Result	Remarks
1	Low Range Frequency Coverage Adjustment	T5 (PNK) (MFC P.C Board)	Error: within 2%	160 kHz optional input
2	Sensitivity Adjustment	Bar Antenna LW Coil T-1 (YLW, BLK) T-3 (WHT) (MFC P.C Board)	Maximum Sensitivity	160 kHz optional input
3	High Range Frequency Coverage Adjustment	C-66 LW OSC Trimmer (MFC P.C Board)	Error: within 2%	340 kHz optional input
4	Sensitivity Adjustment	C-1 LW ANT Trimmer (Trimmer P.C Board)	Maximum Sensitivity	340 kHz optional input

Chart-3

2. MW SECTION ADJUSTMENT (Refer to Figs. 2,6)

Step	Adjustment Item	Adjustment Point	Result	Remarks
1	Low Range Frequency Coverage Adjustment	T-2 (RED) (MFC P.C Board)	Error: within 2%	520 kHz optional input
2	Sensitivity Adjustment	Bar Antenna MW Coil	Maximum Sensitivity	520 kHz optional input
3	High Range Frequency Coverage Adjustment	C-66 MW OSC Trimmer (MFC P.C Board)	Error: within 2%	1,400 kHz optional input
4	Sensitivity Adjustment	C-1 MW ANT Trimmer (Trimmer P.C Board)	Maximum Sensitivity	1,400 kHz optional input

Chart-4

VII. MAIN AMPLIFIER ADJUSTMENT

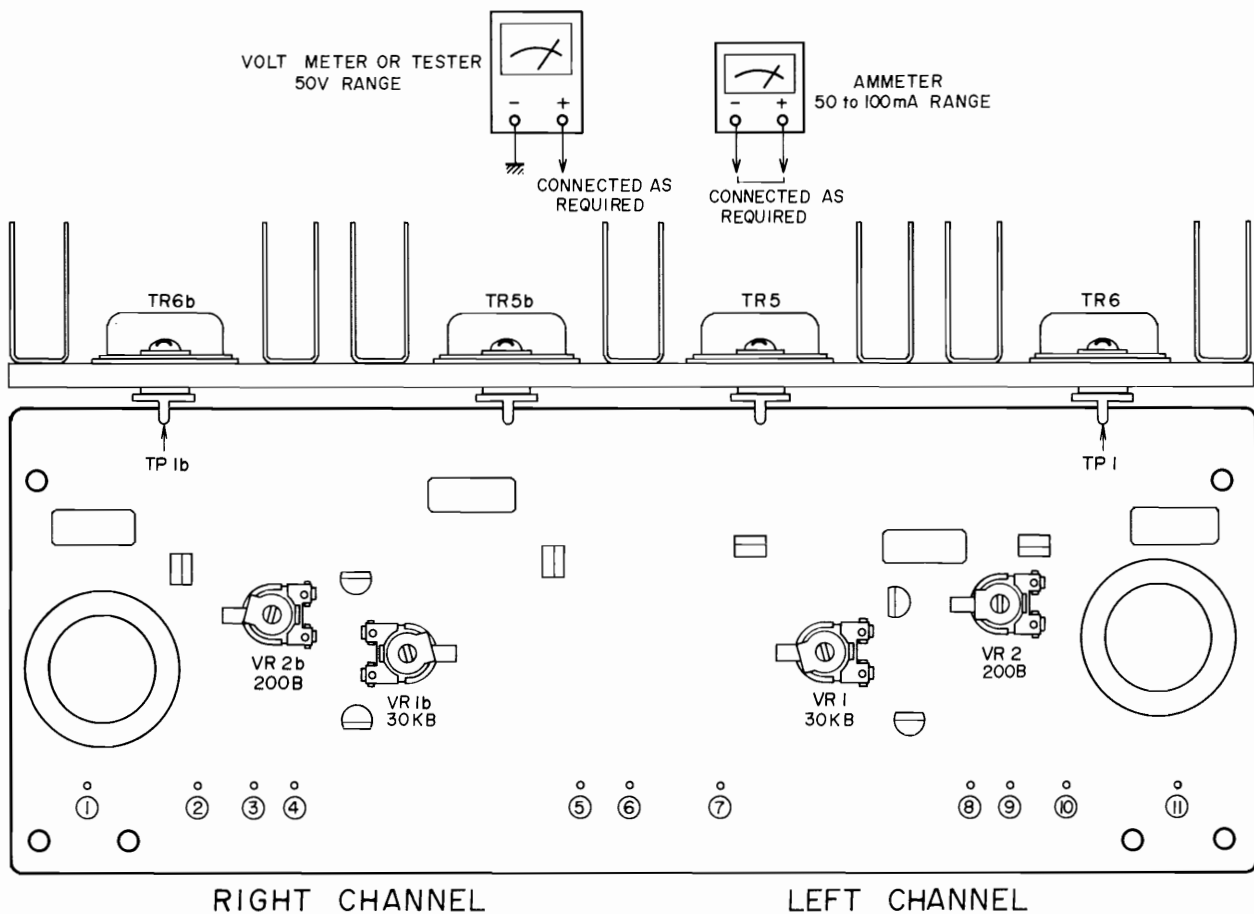

Fig. 7 Main Amp P.C Board AA-5275

1] Idling Current Adjustment (Refer to Fig. 7)

- 1) Disconnect the protection fuse (F-2, F-3) from the Protection Fuse Board.
- 2) Connect a 50 to 100 mA scale ampere meter to the place from which the fuse was removed in step above.
- 3) Adjust Main amplifier P.C Board semi-fixed resistors VR-2 200B (left), and VR-2b 200B (right) to obtain 40 mA on both channels.

2] DC Balance Adjustment (Refer to Fig. 7)

- 1) Set voltmeter or tester to 50V DC range and connect between TP-1 of Main amplifier P.C Board and chassis.
- 2) Adjust semi-fixed resistors VR-1 30 kB (left) and VR-1b 30 kB (right) to obtain half the value of the power supply voltage.

VIII. TUNING CORD THREADING

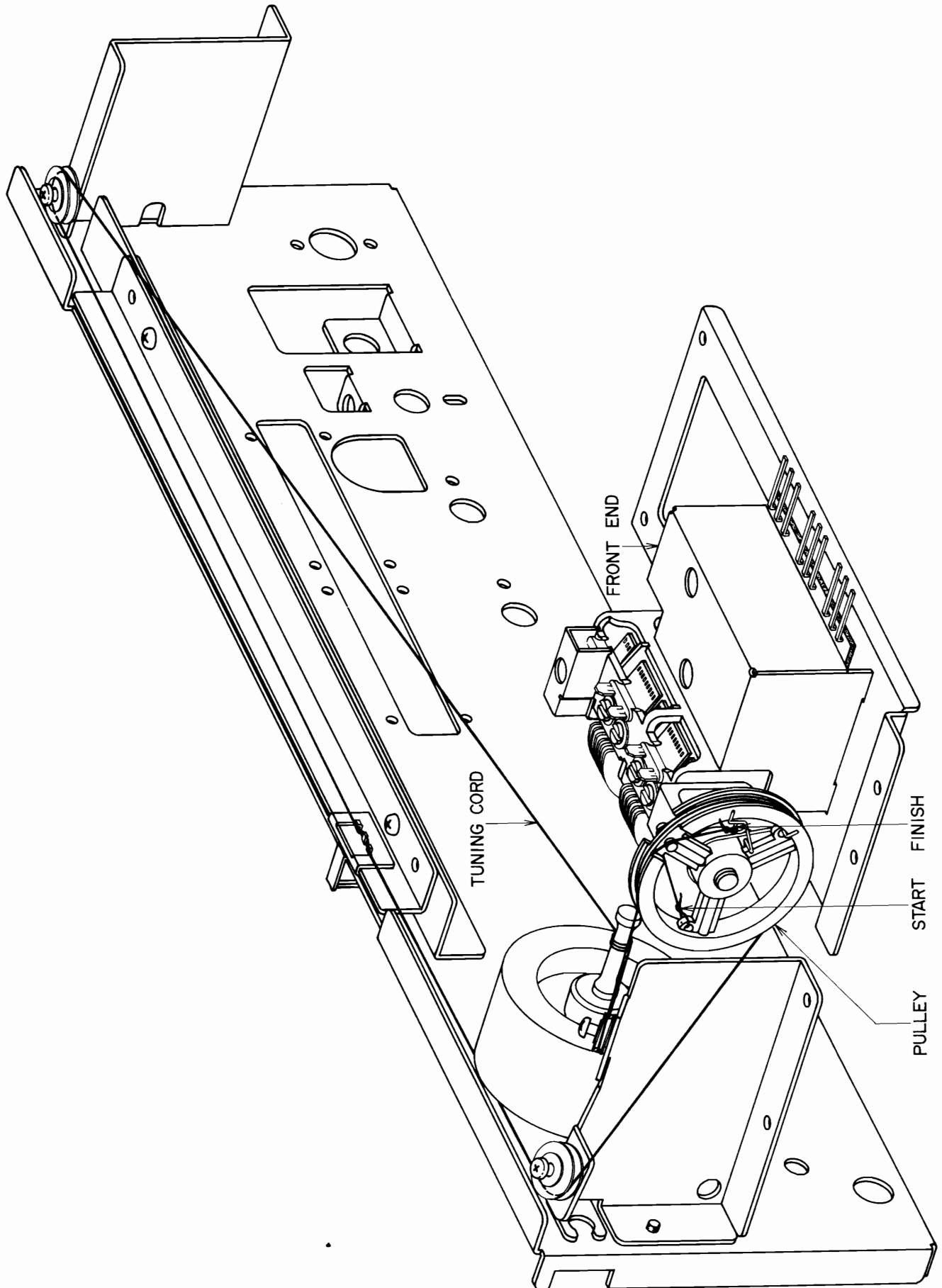

Fig. 8 Tuning Cord Threading

IX. CLASSIFICATION OF VARIOUS P.C BOARDS

1. P.C BOARD INTERCHANGEABILITY CHART

P.C Board	AA-1020	AA-1020L
MFC P.C Board	AA-5270A	*AA-5270A
Main Amp P.C Board	AA-5275	AA-5275
Power Supply P.C Board	AA-5273	*AA-5273
Tone Control P.C Board	AA-5295A	AA-5295A
Filter Mute P.C Board	AA-5276B	AA-5276B
LED P.C Board	AA-5270B	AA-5270B
Protection P.C Board		AA-5271
Trimmer P.C Board		AA-5298

* Mark indicates non-interchangeability

2. COMPOSITION OF VARIOUS P.C BOARDS

- 1) MFC P.C BOARD AA-5270A (AA-1020)
- MFC P.C BOARD AA-5270A (AA-1020L)

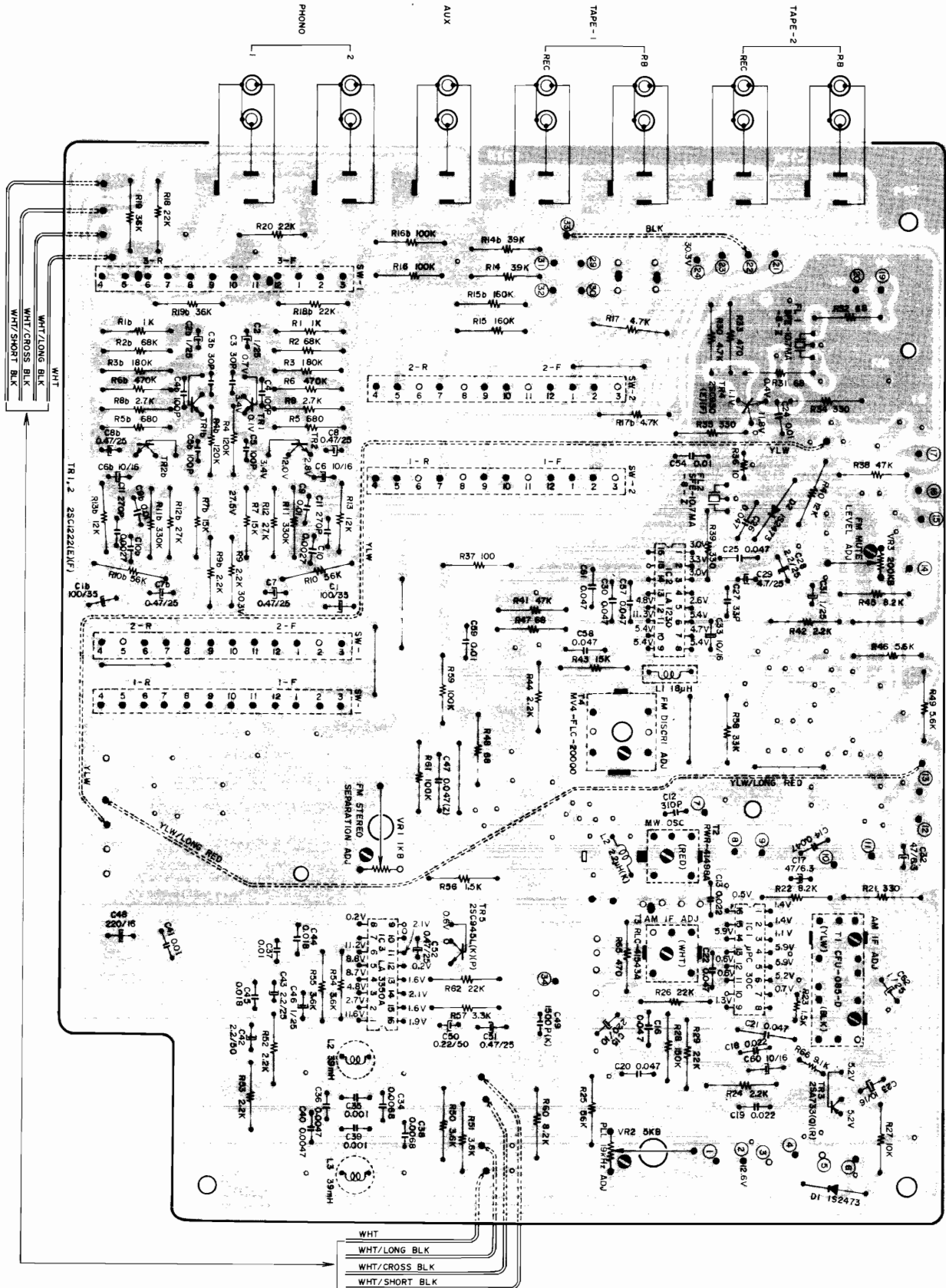

AA-1020

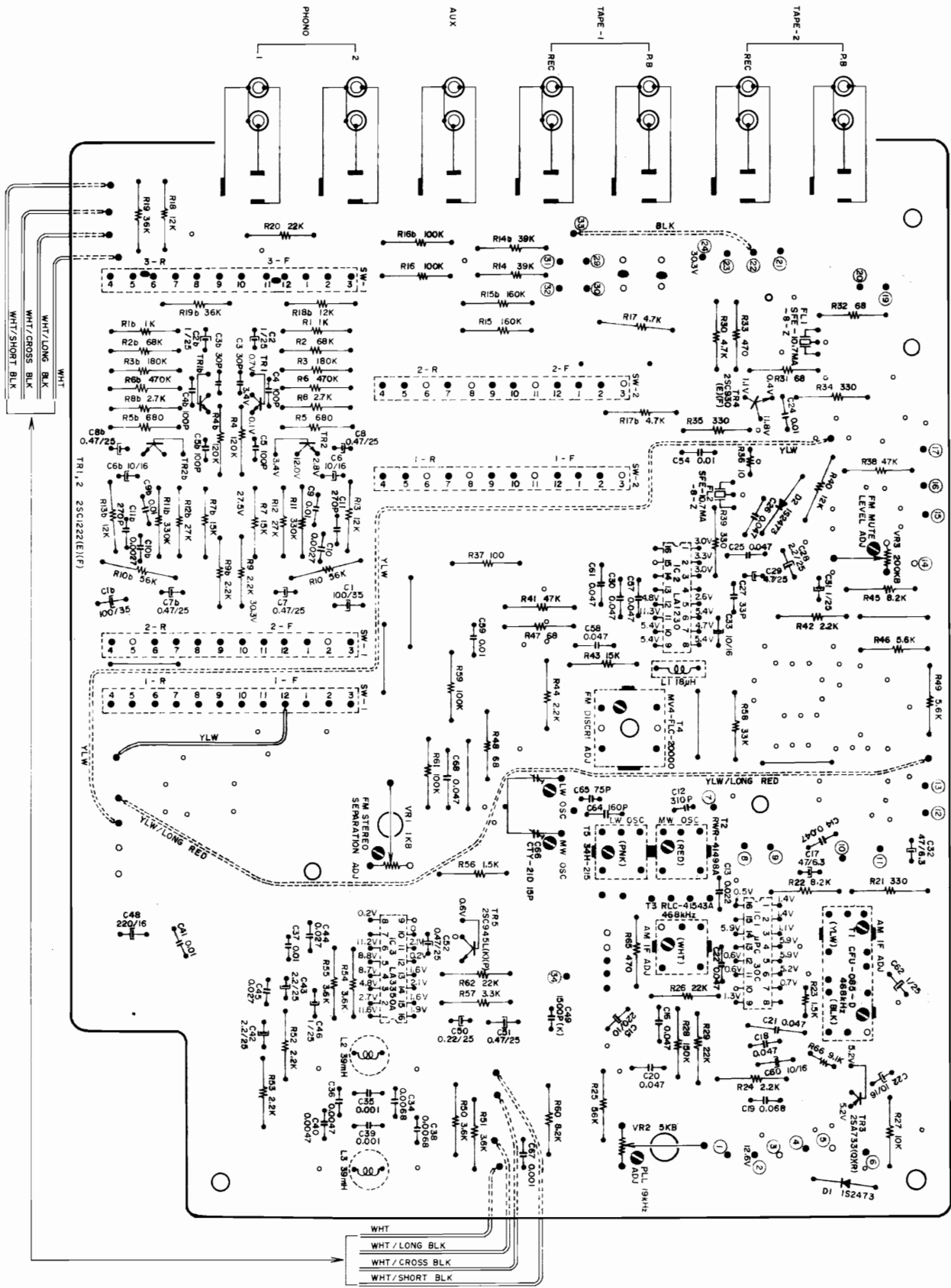

AA-1020L

2) MAIN AMP P.C BOARD

AA-5275

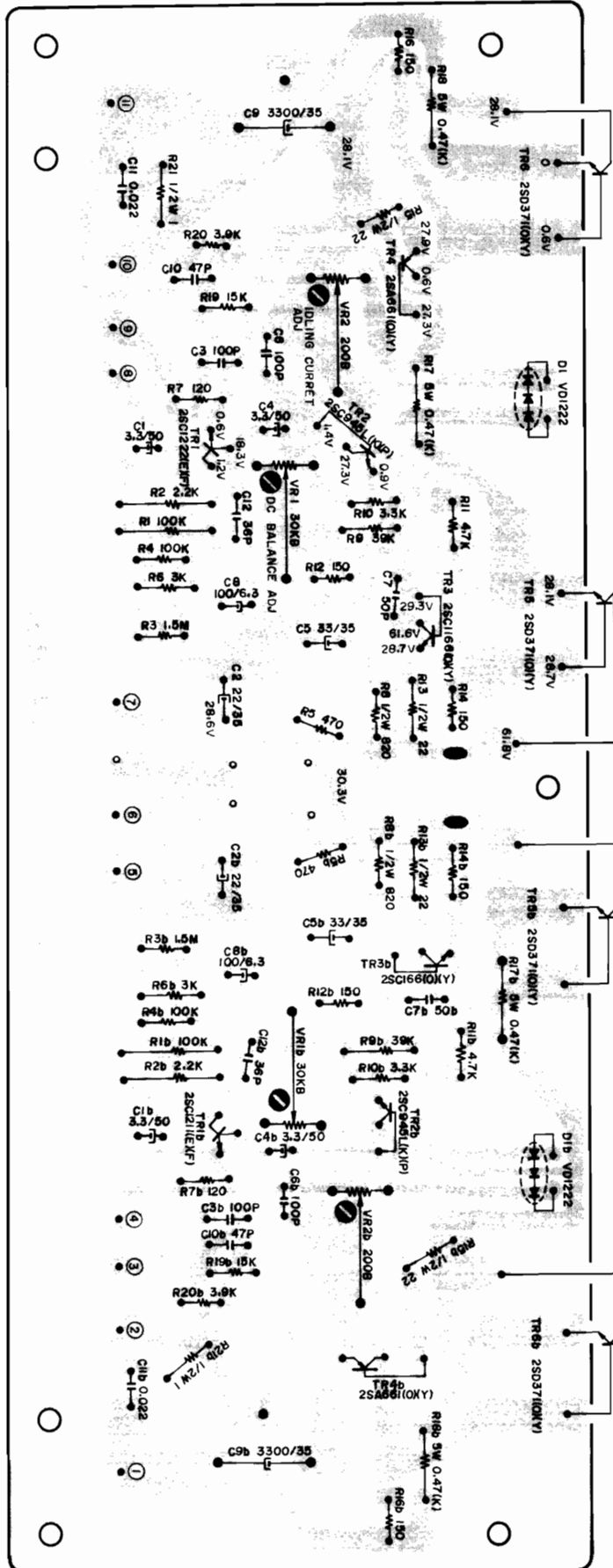

3) POWER SUPPLY P.C BOARD AA-5273

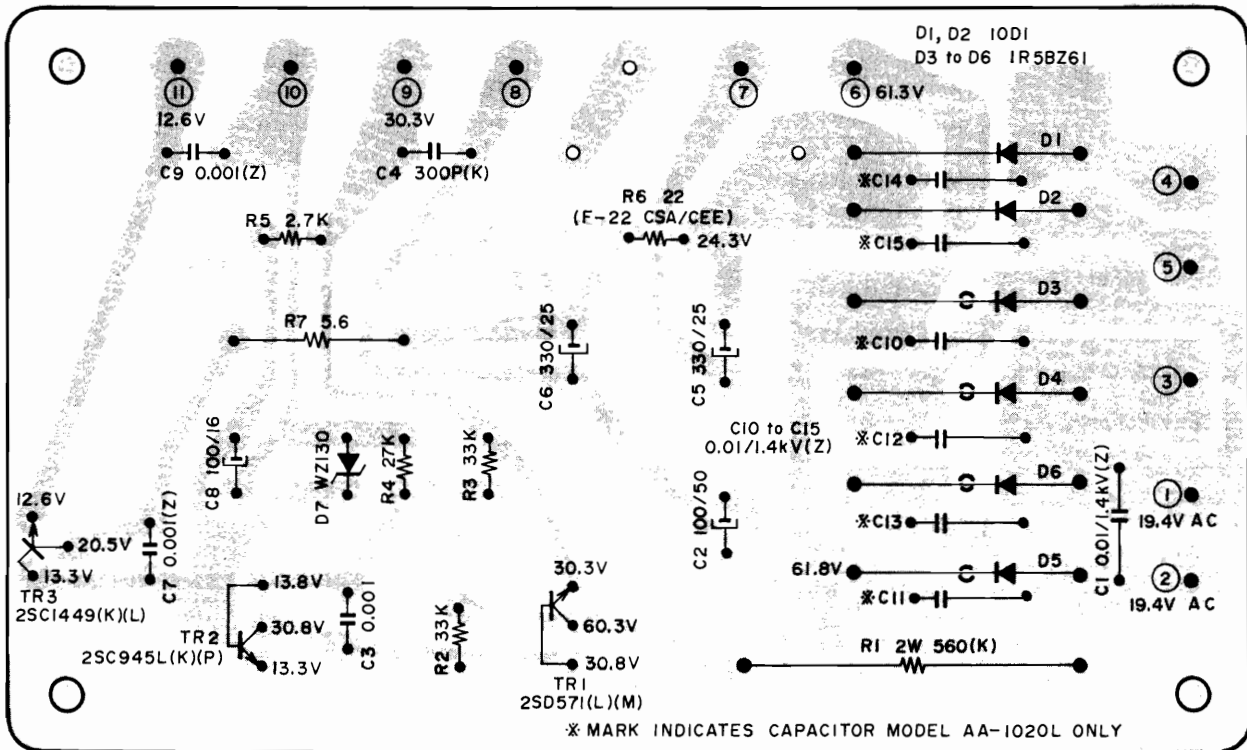

4) FILTER MUTE P.C BOARD AA-5295B

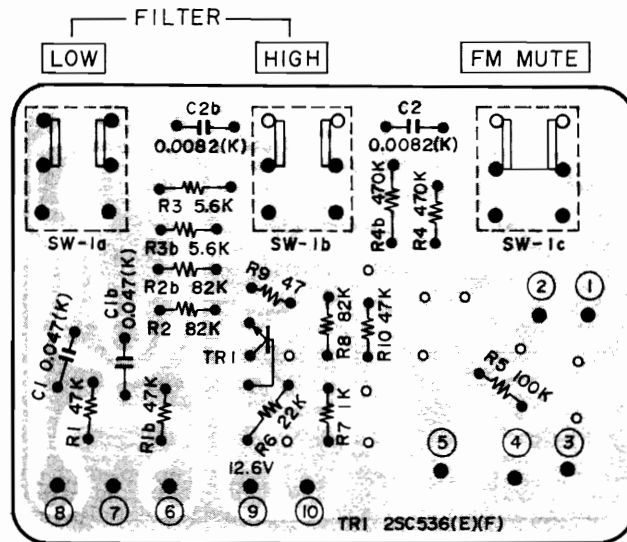

5) TONE CONTROL P.C BOARD AA-5295A

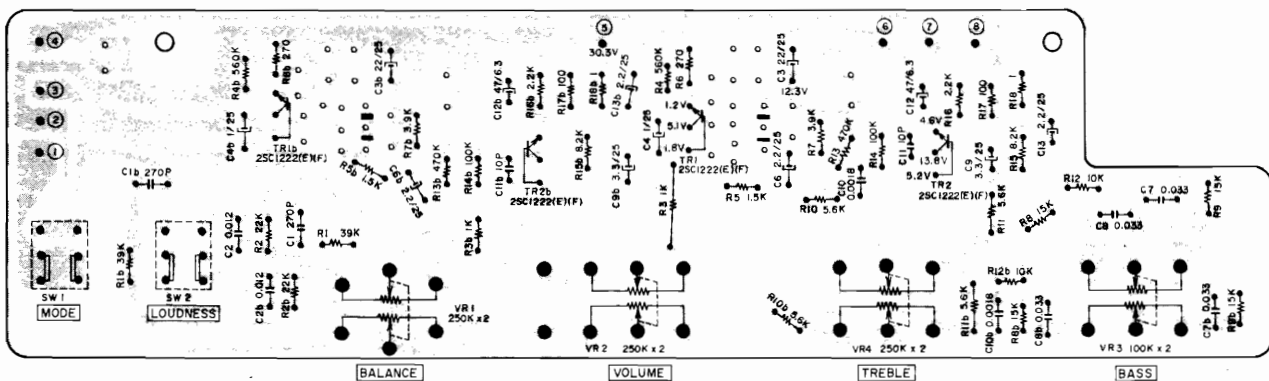

6) LED P.C BOARD

AA-5270B

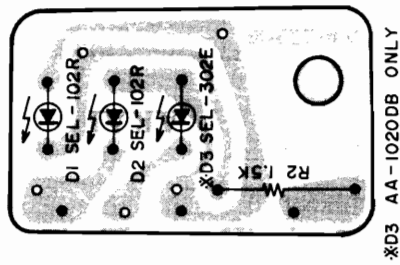

7) TRIMMER P.C BOARD

AA-5298 (AA-1020L)

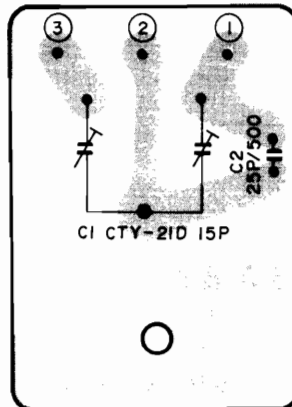

8) PROTECTION P.C BOARD

AA-5271 (AA-1020L)

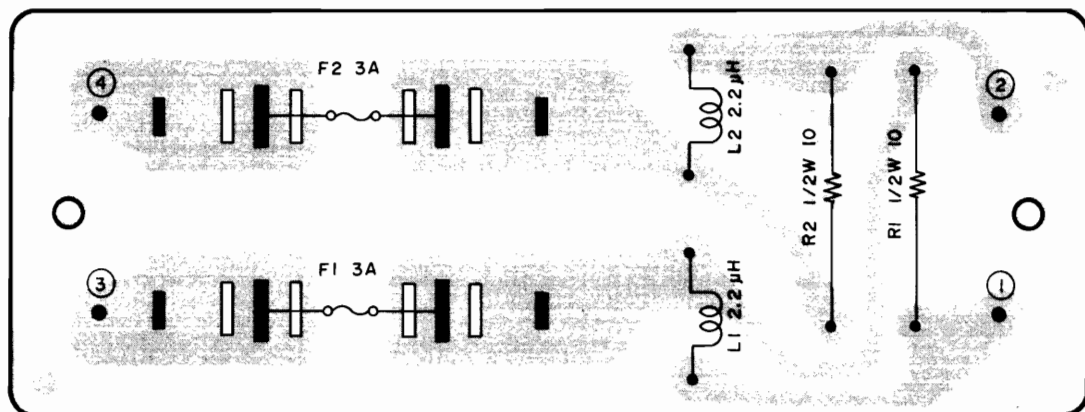

SECTION 2

PARTS LIST

TABLE OF CONTENTS

1. MULTI FUNCTION P.C BOARD (AA-5270A) BLOCK	24
2. MAIN AMP P.C BOARD (AA-5275) BLOCK	25
3. POWER SUPPLY P.C BOARD (AA-5273) BLOCK	25
4. FILTER MUTE P.C BOARD (AA-5295B) BLOCK	25
5. TONE CONTROL P.C BOARD (AA-5295A) BLOCK	26
6. LED P.C BOARD (AA-5270B) BLOCK	26
7. TRIMMER P.C BOARD (AA-5298) BLOCK	26
8. ASSEMBLY BLOCK	27
9. FINAL ASSEMBLY BLOCK	30
10. LIST OF INTERCHANGEABLE SEMICONDUCTORS	31
INDEX	32

Some of the parts in this parts list are only available as a complete assembly, and can not be supplied as individual parts.

HOW TO USE THIS PARTS LIST

1. This parts list is compiled by various individual blocks based on assembly process.
2. When ordering parts, please describe parts number, serial number, and model number in detail.
3. How to read list.

The reference number corresponds with illustration or photo number of that particular parts list.

This number corresponds with the Figure Number.

This number corresponds with the individual parts index number in that figure.

A small "x" indicates the inability to show that particular part in the Photo or Illustration.













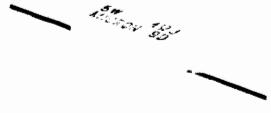





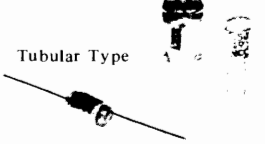

Schematic Diagram Number of individual manufactured part.
(not required for parts order)

Quantity of particular part required.

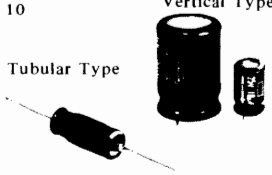
Ref. No.	Parts No.	Description	Schematic No.	Q'ty
FLYWHEEL BLOCK #13				
12-115x	800425	Flywheel Block Assy. Comp.	RDG #13	1
12-116	244506	Flywheel Only	RD-233	1
12-117x	244754	Felt, Flywheel	RD-275	1
12-118	251324	Main Metal Case	RD-236	1
12-119	253080	Main Metal	RD-237	1

4. The symbol numbers shown on the P.C. Board list can be matched with the Composite Views of components of the Schematic Diagram or Service Manual.
5. The indications of Resistors and Capacitors in the photos of P.C. Board are being eliminated.
6. The shape of the parts and parts name, etc. can be confirmed by comparing them with the parts shown on the Electrical Parts Table of P.C. Board.
7. Both the kind of part and installation position can be determined by the Parts Number. To determine where a parts number is listed, utilize Parts Index at end of Parts List.
It is necessary first of all to find the Parts Number. This can be accomplished by using the Reference Number listed at right of parts number in the Parts Index. (meaning of ref. no. outlined in Item 3 above).
8. Utilize separate "Price List for Parts" to determine unit price. The most simple method of finding parts Price is to utilize the reference number.

ELECTRICAL PARTS TABLE

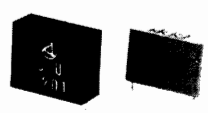
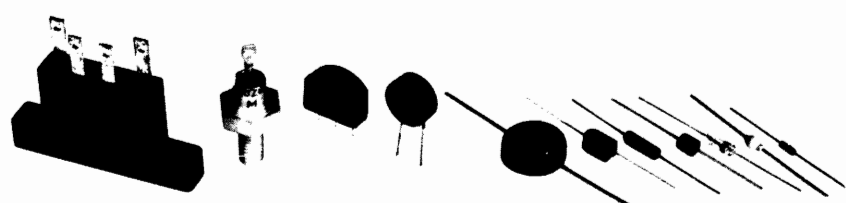
<p>Because the indication of resistors and capacitors in the P. C. Board photos are being eliminated, please confirm parts name and shape by comparing them with the parts shown in this table.</p>	<p>1</p>  <p>Solid Resistor</p>	<p>2</p> <p style="text-align: right;">Stopper Type</p>  <p>Carbon Resistor</p>	<p>3</p>  <p>Metal Oxide Film Resistor</p>	
	<p>4</p>  <p>Cement Resistor</p>	<p>5</p>  <p>Wire-Wound Resistor</p>	<p>6</p>  <p>Thermister</p>	<p>7</p>  <p>Enamel Resistor</p>
	<p>1</p>  <p>MP Capacitor (Tubular Type)</p>	<p>2</p>  <p>Plastic Capacitor</p>	<p>3</p>  <p>Mylar Capacitor</p>	<p>4</p>  <p>VFM (Hi-Q) Capacitor</p>
	<p>5</p>  <p>Mylar Capacitor</p>	<p>6</p>  <p>Tantalum Capacitor</p>	<p>7</p>  <p>Oil Capacitor (Tubular Type)</p>	<p>8</p> <p style="text-align: right;">Vertical Type</p>  <p>Styrol Capacitor</p>
<p>9</p>  <p>Electrolytic Capacitor (Tubular Type)</p>	<p>10</p> <p style="text-align: right;">Vertical Type</p> <p>Tubular Type</p>  <p>Electrolytic Capacitor</p>	<p>11</p>  <p>Ceramic Capacitor</p>	<p>12</p>  <p>Metalized Mylar (Paper) Capacitor</p>	
<p>13</p>  <p>Trimmer Condenser</p>		<p>VR</p>  <p>Semi-Fixed Volume</p>		
<p>L</p>  <p>Ferri Inductor</p>	<p>TR</p>  <p>Transistor</p>			
<p>CR</p>  <p>Spark Quencher</p>	<p>D</p>  <p>Diode (Silicon, Zener, Germanium)</p>			

1 MULTI FUNCTION P.C BOARD (AA-5270A) BLOCK

Symbol No.	Parts No.	Description	Q'ty
1-1	BA649350	Multi Function P.C Board Comp. (AA-5270A)	1
1 2	BA670735	Multi Function P.C Board Comp. (AA-5270A)(1020L)	1
1-IC1	EI650362	IC μ PC-30C	1
1-IC2	EI650586	IC LA-1230	1
1-IC3	EI650597	IC LA-3350A	1
1-TR1,2	ET459810	Transistor 2SC1222(E)(F)	4
1-TR3	ET557965	Transistor 2SA733(Q)(R)	1
1-TR4	ET618873	Transistor 2SC930(E)(F)	1
1-TR5	ET635220	Transistor 2SC945L(K)(P)	1
1-D1,2	ED624903	Silicon Diode 1S2473	2
1-SW1	ES650283	Rotary SW. SR26N 3-9-6 22.5 KC	1
1-SW1	ES664244	Rotary SW. SR26N 5-17-6 225 KC(1020L)	1
1-SW2	ES650305	Rotary SW. SR26N 2-4-5 22.5 KC	1
1-T1	EO650384	AM-1F Trans. CFU-085-D 468 kHz	1
1-T2	EO650395	OSC. Coil RWR-41498A	1
1-T3	EO650373	AM-1F Trans. RLC-41543A 468 kHz	1
1-T4	EO650608	Discri Coil MV4-FLC-20000	1
1-T5	BT633025	LW OSC. Trans. 34H-215(1020L)	1
1-D1,2	ED624903	Silicon Diode 1S2473	2
1-VR1	EV484863	Semi-fixed/Vol. V10K8-4-2 1 k Ω (Metalized Film)	1
1-VR2	EV499364	Semi-fixed/Vol. V10K8-4-2 5 k Ω	1
1-VR3	EV465017	Semi-fixed/Vol. V8K4-1 200 k Ω	1
1-L1	EO650610	Inductor 144LZ 18 μ H(J)	1
1-L2,3	EO650428	Inductor 146LY 39 MH(J)	2
1-L4	EO539820	Peaking Coil 2.2 μ H(K)	1
1-FL1,2	ER650430	Ceramic Filter SFE-10.7 MA-8-Z	2
1 3	TA646738	Switch Support	1
1-4	ZS422076	Screw, pan head 3x5	1
1-5	EJ650272	Pin Jack 14P JPJ379-1-1	1
1-6	MZ656807	Jumper Wire, P.C Board 12.5 mm	8
1-7	EJ539662	Wrapping Post 1x17	28
1-8	EJ539662	Wrapping Post 1x17 (1020L)	29
Capacitor, Vertical Type			
1-C1	EC455354	Elect. 100 μ F 35WV	2
1-C2	EC450055	Elect. 1 μ F 25WV	2
1-C3	EC556018	VFM 30PF(K) 50WV	2
1-C4,5	EC290531	VFM 100PF(K) 50WV	4
1-C6	EC329758	Elect. 10 μ F 16WV	2
1-C7	EC622991	Elect. 0.47 μ F 25WV	2
1 C8	EC368256	Elect. 0.47 μ F 25WV	2
1-C9	EC650340	Ceramic DD312A 0.01 μ F(J) 50WV	2
1-C10	EC650351	Ceramic DD360A 0.0027 μ F(J) 50WV	2
1-C11	EC516723	Styrol 270PF(K) 50WV	2
1-C12	EC650406	Styrol 310PF(J) 50WV	1
1-C13	EC650417	Ceramic DD380-950 BC 0.022 μ F(M) 50WV	1
1-C14	EC427228	Ceramic DD111FZ 0.047 μ F(Z) 50WV	1
1 C15	EC329782	Elect. 220 μ F 10WV	1
1-C16	EC427228	Ceramic DD111FZ 0.047 μ F(Z) 50WV	1
1-C17	EC329771	Elect. 47 μ F 6.3WV	1
1 C18	EC650417	Ceramic DD380-950 BC 0.022 μ F(M) 50WV	1
1-C18	EC658012	Ceramic DD380-950 BC 0.047 μ F(M) 50WV(1020L)	1
1-C19	EC650417	Ceramic DD380-950 BC 0.022 μ F(M) 50WV	1
1-C19	EC654041	Ceramic DD312-950 BC 0.068 μ F(M) 50WV(1020L)	1
1-C20to22	EC427228	Ceramic DD111FZ 0.047 μ F(Z) 50WV	3
1-C23	EC320051	Elect. 10 μ F 16WV	1

Symbol No.	Parts No.	Description	Q'ty
1-C24	EC551441	Ceramic DD106FZ 0.01 μ F(Z) 50WV	1
1-C25,26	EC427228	Ceramic DD111FZ 0.047 μ F(Z) 50WV	2
1-C27	EC650463	Ceramic RD204 NPO33PF(K) 50WV	1
1-C28	EC220432	Elect. 2.2 μ F 25WV	1
1-C29	EC450527	Elect. 4.7 μ F 25WV	1
1-C30	EC427228	Ceramic DD111FZ 0.047 μ F(Z) 50WV	1
1-C31	EC450055	Elect. 1 μ F 25WV	1
1 C32	EC329771	Elect. 47 μ F 6.3WV	1
1-C33	EC320051	Elect. 10 μ F 16WV	1
1-C34	EC650496	Ceramic DD310A 0.0068 μ F(J) 50WV	1
1-C35	EC650474	Ceramic DD340-257A 0.001 μ F 50WV	1
1-C36	EC650485	Ceramic DD380A 0.0047 μ F(J) 50WV	1
1-C38	EC650496	Ceramic DD310A 0.0068 μ F(J) 50WV	1
1-C39	EC650474	Ceramic DD340-257A 0.001 μ F(J) 50WV	1
1-C40	EC650485	Ceramic DD380A 0.0047 μ F(J) 50WV	1
1-C42,43	EC220432	Elect. 2.2 μ F 25WV	2
1-C44,45	EC650878	Ceramic DD310-950BC 0.027 μ F(K) 50WV	2
1-C46	EC450055	Elect. 1 μ F 25WV	1
1-C48	EC321208	Elect. 220 μ F 16WV	1
1-C49	EC666494	Styrol 1500PF(K) 50WV	1
1-C50	EC522167	Solid Aluminum 0.22 μ F(M) 25WV	1
1-C51	EC621257	Solid Aluminum 0.47 μ F(M) 25WV	1
1-C52	EC368256	Elect. 0.47 μ F 25WV	1
1-C54	EC551441	Ceramic DD106FZ 0.01 μ F(Z) 50WV	1
1-C57,58	EC427228	Ceramic DD111FZ 0.047 μ F(Z) 50WV	2
1-C59	EC551441	Ceramic DD106FZ 0.01 μ F(Z) 50WV	1
1-C60	EC320051	Elect. 10 μ F 16WV	1
1-C61	EC427228	Ceramic DD111FZ 0.047 μ F(Z) 50WV	1
1-C62	EC450055	Elect. 1 μ F 25WV	1
1-C64	EC523293	VFM 160PF(J) 50WV(1020L)	1
1-C65	EC485111	VFM 75PF(J) 50WV(1020L)	1
1-C66	EC675742	Trimmer CTY-21D 15PF(1020L)	1
1-C67	EC469708	Styrol 1000PF(J) 50WV(1020L)	1
1-C68	EC658012	Ceramic DD310-950 BC 0.047 μ F(M) 50WV(1020L)	1

Carbon Resistor Omitted

2 MAIN AMP P.C BOARD (AA-5275) BLOCK

Symbol No.	Parts No.	Description	Q'ty
2-1	BA649427	Main Amp P.C Board Comp. (AA-5275)	1
2-TR1	ET459810	Transistor 2SC1222(E)(F)	2
2-TR2	ET635220	Transistor 2SC945L(K)(P)	2
2-TR3	ET650654	Transistor 2SC1166(O)(Y)	2
2-TR4	ET650665	Transistor 2SA661(O)(Y)	2
2-D1	ED490511	Varistor VD1222	2
2-VR1	EV593368	Semi-fixed/Vol. V10K8-4-2 30 k Ω	2
2-VR2	EV573366	Semi-fixed/Vol. V10K8-4-2 200B	2
2-2	EJ539662	Wrapping Post 1x17	11
2-R17,18	ER622978	Metal Plate/R. MPC71F1 5W 0.47 Ω (K)	4
Capacitor, Vertical Type			
2-C1	EC539943	Elect. 3.3 μ F 50WV	2
2-C2	EC405044	Elect. 22 μ F 35WV	2
2-C3	EC290531	VFM 100PF(K) 50WV	2
2-C4	EC539943	Elect. 3.3 μ F 50WV	2
2-C5	EC590848	Elect. 33 μ F 35WV	2
2-C6	EC290531	VFM 100PF(K) 50WV	2
2-C7	EC357827	VFM 50PF(K) 50WV	2
2-C8	EC220364	Elect. 100 μ F 6.3WV	2
2-C9	EC650698	Elect. 3300 μ F 35WV	2
2-C10	EC487394	VFM 47PF(K) 50WV	2
2-C11	EC684707	Ceramic DD109F 0.022 μ F(Z) 50WV	2
2-C12	EC664650	VFM 36PF(K) 50WV	2

Carbon Resistor Omitted

3 POWER SUPPLY P.C BOARD (AA-5273) BLOCK

Symbol No.	Parts No.	Description	Q'ty
3-1	BA649383	Power Supply P.C Board Comp. (AA-5273)	1
3-2	BA662984	Power Supply P.C Board Comp. (AA-5273)(CEE)	1
3-3	BA662995	Power Supply P.C Board Comp. (AA-5273)(CSA)	1
3-4	BA670757	Power Supply P.C Board Comp. (AA-5273)(1020L)	1
3-5	BA670768	Power Supply P.C Board Comp. (AA-5273)(1020L)(CEE)	1
3-TR1	ET655356	Transistor 2SD571(L)(M)	1
3-TR2	ET635220	Transistor 2SC945L(K)(P)	1
3-TR3	ET649034	Transistor 2SC1449(K)(L)	1
3-D1,2	ED224526	Silicon Diode 10D1	2
3-D3to6	ED650621	Silicon Diode 1R5BZ61	4
3-D7	ED539976	Zener Diode WZ-130	1
3-6	ZW465715	Washer (SPC) D3.2x6x0.5t	1
3-7	ZW273756	Nut M3	1
3-8	ZS421806	Screw, pan head 3x8	1
3-9	TA646874	Power Supply P.C Board Table	1
3-10	ZS325495	Tapping Screw #2 3x6 (BR)	3
3-11	EJ539662	Wrapping Post 1x17	11
3-R1	ER653578	Metal Oxide Film/R. 2W 560 Ω (K)	1

Capacitor, Vertical Type

3-C1	EC551160	Ceramic NB821YZ 0.01 μ F(Z) 1.4 kWV	1
3-C2	EC321221	Elect. 100 μ F 50WV	1
3-C3	EC551441	Ceramic DD106FZ 0.01 μ F(Z) 50WV	1
3-C4	EC551215	VFM 300PF(K) 50WV	1
3-C5,6	EC324538	Elect. 330 μ F 25WV	2
3-C7	EC551441	Ceramic DD106FZ 0.01 μ F(Z) 50WV	1
3-C8	EC220127	Elect. 100 μ F 16WV	1
3-C9	EC551441	Ceramic DD106FZ 0.01 μ F(Z) 50WV	1
3-C10to15	EC551160	Ceramic NB821YZ 0.01 μ F(Z) 1.4 kWV(1020L)	6

Carbon Resistor Omitted

4 FILTER MUTE P.C BOARD (AA-5295B) BLOCK

Symbol No.	Parts No.	Description	Q'ty
4-1	BA649451	Filter Mute P.C Board Comp. (AA-5295B)	1
4-TR1	ET342707	Transistor 2SC536(E)(F)	1
4-SW1	ES624701	Push SW. 3FT-0005FF1320	1
4-2	EJ539662	Wrapping Post 1x17	10
4-C1	EC650788	Ceramic/C. DD310-950BC 0.047 μ F(K) 50WV	2
4-C2	EC379833	Mylar/C. 0.0082 μ F(K) 50WV	2

Carbon Resistor Omitted

5 TONE CONTROL P.C BOARD (AA-5295A) BLOCK

Symbol No.	Parts No.	Description	Q'ty
5-1	BA649440	Tone Control P.C Board Comp. (AA-5295A)	1
5-TR1,2	ET459810	Transistor 2SC1222(E)(F)	4
5-VR1	EV650711	Co-axial 2-throw/Vol. V24L5GPHN 1Z250kx2	1
5-VR2	EV650700	Co-axial 2-throw/Vol. V24L5GPHN 3BM250kx2	1
5-VR3,4	EV650722	Co-axial 2-throw/Vol. V24L5GPHN 1kB 100kx2	2
5-2	EJ539662	Wrapping Post 1x17	8
Capacitor, Vertical Type			
5-C1	EC336194	VFM 270PF(J) 50WV	2
5-C2	EC650733	Ceramic DD360-950BC 0.012 μ F(K) 50WV	2
5-C3	EC350684	Elect. 22 μ F 25WV	2
5-C4	EC450055	Elect. 1 μ F 25WV	2
5-C6	EC220432	Elect. 2.2 μ F 25WV	2
5-C7,8	EC379157	Mylar 0.033 μ F(J) 50WV	4
5-C9	EC331828	Elect. 3.3 μ F 25WV	2
5-C10	EC650520	Ceramic DD360A 0.0018 μ F(K) 50WV	2
5-C11	EC474671	FM 10PF(K) 50WV	2
5 C12	EC329771	Elect. 47 μ F 6.3WV	2
5-C13	EC220432	Elect. 2.2 μ F 25WV	2

Carbon Resistor Omitted

6 LED P.C BOARD (AA-5270B) BLOCK

Symbol No.	Parts No.	Description	Q'ty
6-1	BA649473	LED P.C Board Comp. (AA-5270B)	1
6-D1,2	ED650812	Luminous Diode SEL-102R	2
6-2	TA646648	Indicator Table	1
6-3	ZS422076	Screw, pan head 3x5	1

Carbon Resistor Omitted

7 TRIMMER P.C BOARD (AA-5298) BLOCK

Symbol No.	Parts No.	Description	Q'ty
7-1	BA670814	Trimmer P.C Board Comp. (AA-5298)	1
7-C1	EC675742	Trimmer/C. CTY-21D 15PF	1
7-C2	EC428995	FM/C. 25PF(J) 500WV	1
7-2	EJ539662	Wrapping Post 1x17	3

8 PHOTO OF ASSEMBLY BLOCK

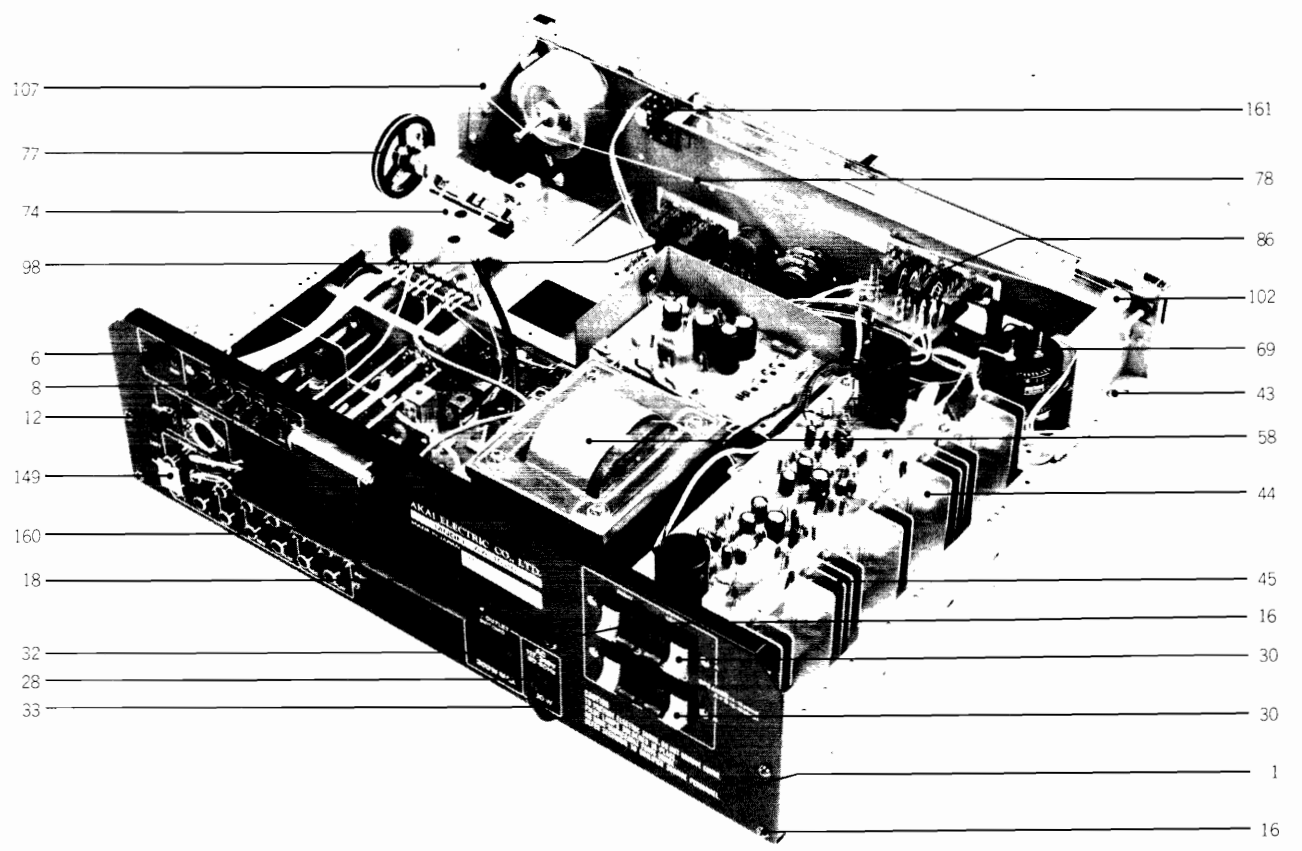
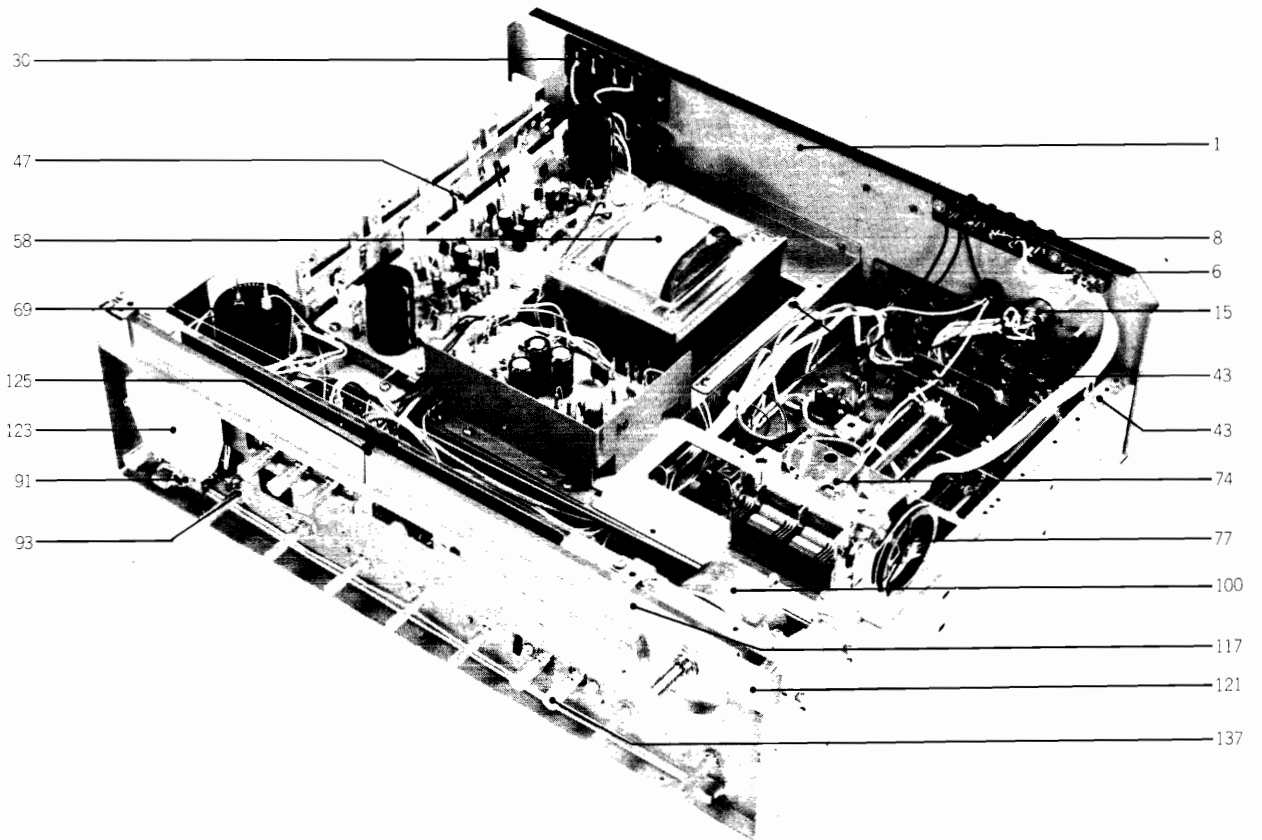

8) ASSEMBLY BLOCK

Ref. No.	Parts No.	Description	Schematic No.	Q'ty	Ref. No.	Parts No.	Description	Schematic No.	Q'ty
REAR PANEL BLOCK					ASSEMBLY BLOCK				
8-1	SP645748	Rear Panel 1	AA-5207	1	8-54	TA641608	Reinforcement Channel	AA-5202	1
8-2x	SP647910	Rear Panel 3 (CEE)	AA-5207	1	8-55x	TA646852	Side Plate Metal Parts	AA-5201	2
8-3x	SP645750	Rear Panel 2 (CSA)	AA-5207	1	8-56x	MZ646492	Stopper	AA-5205	1
8-4x	SP675145	Rear Panel 9 (1020L)	AA-5207	1	8-57	TA646863	Transformer Table	AA-5204	1
8-5x	SP679645	Rear Panel 10 (1020L) (CEE)	AA-5207	1	8-58	BT668294	Power Trans. AA-1020T-5	38-4-396	1
8-6	ES422436	Slide SW. SL-222B4C	25-3-40	1	8-59x	BT665796	Power Trans. AA-1020T-3 (CEE)	38-4-369	1
8-7x	ZS608185	Screw, pan head 2.6x4		2	8-60x	BT665774	Power Trans. AA-1020T-2 (CSA)	38-4-368	1
8-8	EZ655187	5P Antenna Terminal Plate	32-1-69	1	8-61x	ZW273914	Spring Washer M4		4
8-9x	ZS421740	Screw, pan head 3x8		9	8-62x	ZW413188	Nut M4		4
8-10x	ZW273756	Nut M3		2	8-63x	BA670814	Trimmer P.C Board Comp. (1020L)	AA-5298	1
8-11x	ZW562476	Earth Lug M3		1	8-64x	EJ551035	Wrapping Terminal. 4P T-5251	32-1-36	1
8-12	SK652397	Knob 0512-2	34-1-4	1	8-65x	ML668823	Angle	AA-52102	1
8-13x	ZS675382	Earth Screw AA-1020L	AA-52103	1	8-66x	EJ539447	Earth Terminal 2P T-4460	32-1-32	1
8-14x	ZW652408	Washer (SPC) D3.2x10x0.5t		1	8-67x	TA646514	Reinforcement Plate	AA-5208	1
8-15	EJ299316	Jack, 5P din	31-1-24	1	8-68x	TA646525	Capacitor Table	AA-5209	1
8-16	ZS447761	Tapping Screw #2 3x6 (BR)(Black)		4	8-69	EC650114	Elect. 6800µF 63WV (Lug Type)	24-10-100	1
8-17x	TA530910	Antenna Channel	91-5029	1	8-70x	ZW646751	Nut Plate	AA-5238	2
8-18	EE650248	Bar Antenna	55-1-25	1	8-71x	ZS422076	Screw, pan head 3x5		10
8-19x	EE664233	Bar Antenna (1020L)	55-1-31	1	8-72x	TA646683	P.C Board Cushion	AA-5229	1
8-20x	TA378268	Antenna Support	AA-5552	1	8-73x	TA646378	Bari. Con. Table	AA-5236	1
8-21x	TA625847	Antenna Holder (1020L)	2-7-46	1	8-74	EE562735	Front End FB112U21	57-2-29	1
8-22x	ZS552600	Screw, pan head 4x50		1	8-75x	TA616847	Front End FB112U23 (1020L)	57-2-32	1
8-23x	ZW273914	Spring Washer M4		2	8-76x	ZW646740	Bari. Con. Washer	AA-5237	2
8-24x	ZW420682	Washer (Nylon) D4.2x9x0.5t		2	8-77	MI650136	Dial Wheel D45 N01008	2-15-11	1
8-25x	ZW420682	Washer (Nylon) D4.2x9x0.5t (1020L)		1	8-78	TA207347	Thread 1.8m		1
8-26x	ZW345442	Washer (Nylon) D4.2x9x1t (1020L)		1	8-79x	TC494267	Lamp Cover	CG-2206	1
8-27x	ZW604416	Nut M4		1	8-80x	TA646896	Rail Table	AA-5215	1
8-28	EJ631945	Strain Relief SR-4N-4	2-7-49	1	8-81x	TA646582	Spacer	AA-5219	2
8-29x	EZ246936	Strain Relief SR-6W-1 (1020L)	2-7-8	1	8-82x	MB650147	Rubber Bushing No. 6552	3-13-44	1
8-30	EJ650250	Speaker Terminal	32-1-68	2	8-83x	EL650158	Lamp (Cord Type) 14V 100MA(200M/Mx2)	28-2-48	1
8-31x	ZW273756	Nut M3		4	8-84x	EC551160	Ceramic/C. NB821 YZ 0.01µF(Z) 1.4 kWV	24-5-55	1
8-32	EJ650261	AC Consent U/L S-16432	31-1-147	1	8-85x	EC565896	Ceramic/C. DP6600YM 0.01µF(P) 1.4 KWV (CSA)	24-5-58	1
8-33	EW374894	AC Cord 3M (CUL)	26-3-19	1	8-86	ES665875	Push SW. SDG-1P TV-3 U/L	25-5-199	1
8-34x	EW516600	AC Cord VM-0065 (CEE)	26-3-28	1	8-87x	ES672254	Push SW. SDG-5P TV-3 U/L	25-5-207	1
8-35x	EW516600	AC Cord VM-0065 (1020L)(CEE)	26-3-28	1	8-88x	MZ646558	SW. Table	AA-5216	1
8-36x	EJ631945	Strain Relief SR-4N-4	2-7-49	1	8-89x	TA646571	Panel Support	AA-5218	2
8-37x	EZ246936	Strain Relief SR-6W-1 (CEE)	2-7-8	1	8-90x	ZS406416	Tapping Screw #2 3x8 (Countersunk)		8
8-38x	EJ631945	Strain Relief SR-4N-4 (1020L)(CEE)	2-7-49	1	8-91	EJ634915	Mic. Jack 3PMJ1	31-2-50	1
8-39x	ZW273881	Earth Lug M4 (CEE)		1	8-92x	ZW270191	E Jack Nut		1
8-40x	ZW273892	Toothed Lock Washer M4 (CEE)		1	8-93	ES650182	Rotary SW. SR-321N 1-2-4 30R	25-7-45	1
8-41x	ZS417150	Screw, pan head 4x6 (CEE)		1	8-94x	ER653556	Metal Oxide Film/R. 1W 220 ohms(K)	35-15-17	2
8-42x	ZW416698	Nut M4 (CEE)		1	8-95x	ER559034	Metal Oxide Film/R. 2W 330 ohms(K)	35-15-16	2
MAIN AMP BLOCK					8-96x	ER428567	Solid/R. RC1/2W 2.2M(K) (CSA)	35-5-4	1
8-43	ZS325495	Tapping Screw #2 3x6 (BR)		72	8-97x	EZ624047	Cord Retainer (CSA)	2-7-48	1
8-44	EZ646885	Heat-sink Plate	AA-5212	1	8-98	ES650171	Push SW. 2FT-0001FF4920	25-5-184	1
8-45	ET650632	Transistor 2SD371(O)(R)	45-1-215	4	8-99x	ZS432674	Screw, pan head 3x3		2
8-46x	EZ624734	Mylar Sheet	45-16-18	4	8-100	BF649337	Flywheel Block Comp.		1
8-47	TA541552	Transistor Mt. Plate	92-5007	4	8-101x	TA646593	Roller Table L	AA-5220	1
8-48x	ZW650643	Insulator Washer AC-310	45-16-19	8	8-102	MR530651	Roller A	91-5008	2
8-49x	ZS380046	Screw, pan head 3x10		8	8-103x	ZS530673	Roller Screw A	91-5010	3
8-50x	TA646536	Main Amp Support A	AA-5213	1	8-104x	MB650147	Rubber Bushing No. 6552	3-13-44	2
8-51x	TA646547	Main Amp Support B	AA-5213	1	8-105x	EL650158	Lamp (Cord Type) 14V 100MA (200M/Mx2)	28-2-48	1
8-52x	ZS447840	Tapping Screw #2 3x8 (BR)		2	8-106x	MZ664211	Roller Table R-2	AA-52104	1
8-53x	ZW666180	Washer D3.2x6x0.5t		8	8-107	MR530662	Roller B	91-5009	1

Ref. No.	Parts No.	Description	Schematic No.	Q'ty
8-108x	EL650193	Lamp (Cord Type) 14V 100MA (650M/Mx2)	28-2-47	1
8-109x	EZ610773	Fuse Angle A8	A8-5054	2
8-110x	EZ655198	Fuse Holder 5P Base	40-1-71	1
8-111x	EZ665785	Fuse Holder 6P (Large) (CSA)	40-1-82	1
8-112x	EZ665820	Fuse Holder 6P (Small) (CEE)	40-1-83	1
8-113x	TA646762	Connector Bar	AA-5239	2
8-114x	ZW270123	'E' Ring 4M	6-1-9	4
8-115x	ZW260122	Washer (Nylon) D6.1x10x1t		2
8-116x	TA646773	Joint	AA-5240	2
8-117	TA645682	Scale Plate A	AA-5231	1
8-118x	TA675123	Scale Plate E (1020L)	AA-5231	1
8-119x	ZW610503	Washer D11	36-13-2	1
8-120x	ZW610492	Nut M11	36-13-3	1
8-121	TA648314	Lamp Reflect Plate	AA-5251	2
8-122x	EZ646626	Meter Cushion	AA-5223	1
8-123	EM664424	Tuning Meter 85C244	46-1-116	1
8-124x	TA646367	Rail	AA-5234	1
8-125	TA646795	Pointer	AA-5242	1
8-126x	TA646784	Pointer Base	AA-5241	1
8-127x	ZW659147	Adjust. Washer D4.5x10x0.13t		1
8-128x	ZW659158	Adjust. Washer D4.5x10x0.25t		1
8-129x	ZW659160	Adjust. Washer D4.5x10x0.25t		1
8-130x	ZW659171	Adjust. Washer D4.5x10x0.4t		1
8-131x	ZW659182	Adjust. Washer D4.5x10x0.4t		1
8-132x	ZW659193	Adjust. Washer D4.5x10x0.5t		1
8-133x	SP645726	Bottom Plate	AA-5246	1
8-134x	SP664200	Bottom Plate B (CEE)(CSA)	AA-5246	1
8-135x	TA646806	Fuse Cover	AA-5247	1
8-136x	SZ645243	Circular Foot A	CA-6014	4
8-137	SK634410	Push Button Knob J	91-5051	6
8-138x	EJ254957	Lug Plate KP1L	33-3-2	1
8-139x	EJ539447	Earth Terminal 2P T4460	32-1-32	1
8-140x	EF277413	Fuse ST-2 2A (CSA)	39-1-26	1
8-141x	EF602550	Fuse (Semko T Type) 1.25AT 250V (CEE)	39-1-53	1
8-142x	EF666191	Fuse (Semko) 1.6A (CEE)	39-1-54	2
8-143x	EF593706	Fuse (Semko T Type) 500MAT (CEE)	39-1-53	1
8-144x	EF277402	Fuse ST-2 1A (CSA)	39-1-26	1
8-145x	EF623114	Fuse (Semko T Type) 200MAT (CEE)	39-1-53	2
8-146x	EF487438	Fuse ULMF61ML 125V 0.2A (CSA)	39-1-40	2
8-147x	EF659711	Fuse ST-2 1.6A	39-1-26	2
8-148x	ZW562476	Earth Lug M3 (CSA)		1
8-149	EJ645928	Short Pin	AA-5263	1
8-150x	EJ205986	Cramp Terminal 2-SD	32-1-8	1
8-151x	EO539820	Peaking Coil 2.2μH(K) (1020L)	23-1-187	1
8-152x	MZ229138	Wire Bundle Holder N-108 (CSA)	2-35-1	3
8-153x	MZ229138	Wire Bundle Holder N-108	2-35-1	4
8-154x	TA646503	P.C Board Table (CEE)	AA-5206	1
8-155x	EJ665818	AC Cord Repeater Terminal Plate 4P (CEE)	33-2-54	1
8-156x	TA605878	Lead Protector (CEE)	A5-5007	4
8-157x	TA605878	Lead Protector (CSA)	A5-5007	4
8-158x	SE569744	Knob Escutcheon (CEE)	TD-6017	1
8-159x	SE569744	Knob Escutcheon (CSA)	TD-6017	1
8-160	EJ650272	Pin Jack 14P JPJ379-1-1	31-1-148	1
8-161	BA649473	LED P.C Board Comp.	AA-5270B	1

9 PHOTO OF FINAL ASSEMBLY BLOCK

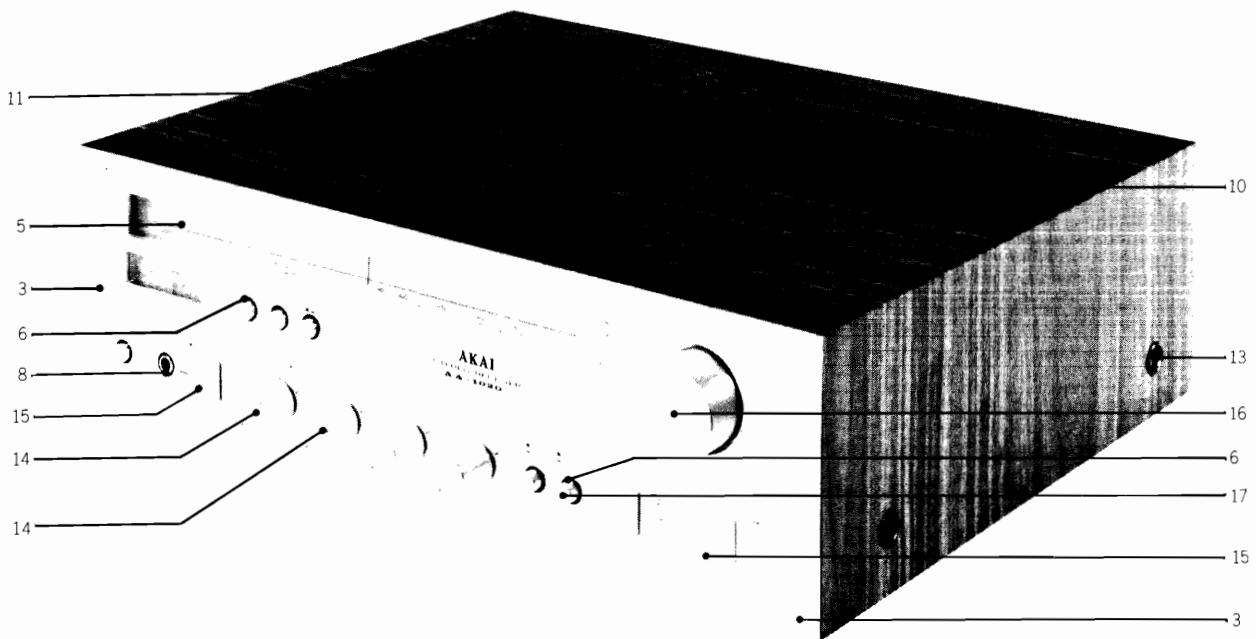

9) FINAL ASSEMBLY BLOCK

Ref. No.	Parts No.	Description	Schematic No.	Q'ty
FRONT PANEL BLOCK				
9-1x	BZ649304	Front Panel Block Comp.		1
9-2x	BZ670713	Front Panel Block Comp. (1020L)		1
9-3	SP645704	Front Panel B	AA-5244	1
9-4x	SP679432	Front Panel C (AA-1020L)	AA-5244	1
9-5	SP645715	Front Plate	AA-5245	1
9-6	SE613888	Button Escutcheon A	CW-6021	6
9-7x	MZ659777	Reflection Stopper	AA-5269	1
9-8	ZW526577	Collar B, Jack	MC-5006	1
ASSEMBLY BLOCK				
9-9x	ZS325495	Tapping Screw #2 3x6 (BR)		4
9-10	BC679408	Case 2	AA-52108	1
9-11	SE641597	Ventilation	AA-5249	1
9-12x	ZW548010	Spot Facing Washer	MU-6028	4
9-13	ZS510344	Screw, binding head 4x12		4
9-14	SK646817	Single Knob	AA-5250	4
9-15	SK646830	Selector Knob	AA-5253	3
9-16	SK646828	Tuning Knob (Small)	AA-5252	1
9-17	SK634410	Push Button Knob J	91-5051	6

10 LIST OF INTERCHANGEABLE SEMICONDUCTORS

As far as service in concerned, in case the original parts cannot be obtained, the interchangeable parts listed below can be substituted.

Original Parts			Interchangeable Parts	
Description	Parts No.	Utilizing P.C Board	Description	Parts No.
2SA661(O)(Y)	ET650665	AA-5275	2SA706-3(1)(2)	ET556020
2SA733(Q)(R)	ET557965	AA-5270A		
2SC536(E)(F)	ET342707	AA-5276B	2SC711(E) 2SC945L(K)(P)	ET380834 ET635220
2SC930(E)(F)	ET618873	AA-5270A		
2SC945L(K)(P)	ET635220	AA-5270A AA-5273 AA-5275	2SC711(E) 2SC536(E)(F) 2SC1647(R)(S)	ET380834 ET370607 ET658181
2SC1166(O)(Y)	ET650654	AA-5275	2SC1124(1)(2)	ET551564
2SC1222(E)(F)	ET459810	AA-5295A AA-5275 AA-5270A	2SC458LG(C) 2SC1000(Y)(GR) 2SC1313(G)(H)	ET523405 ET654862 ET604124
2SC1449(K)(L)	ET649034	AA-5273	2SD313(D)(E) 2SD234(O)(Y)	ET556086 ET393568
2SD371(O)(Y)	ET650632	AA-5275	2SC1111(O)(Y)	ET556648
2SD571(L)(M)	ET655356	AA-5273	2SD234(O)(Y)	ET393568
10D1	ED224526	AA-5273	1N4003 1N4002	ED570295 ED511907
1R5BZ61	ED650621	AA-5273	HIFI-SPECIAL 400V	ED558033
WZ130	ED539976	AA-5273		
1S2473	ED624903	AA-5270A	1S1588	ED557447
VD1222	ED490511	AA-5275	STV-3H	ED556514
SEL102R	ED650812	AA-5270B		
μPC30C	EI650362	AA-5270A		
LA1230	EI650586	AA-5270A		
LA3350A	EI650597	AA-5270A		

INDEX

Parts No.	Ref. No. & Symbol No.	Parts No.	Ref. No. & Symbol No.	Parts No.	Ref. No. & Symbol No.	Parts No.	Ref. No. & Symbol No.	Parts No.	Ref. No. & Symbol No.
BA649350	1-1	EC551441	3-C7	EL650158	8-83x	SK634410	9-17	ZW273914	8-61x
BA649383	3-1	EC551441	3-C9	EL650158	8-105x	SK634410	8-137	ZW345442	8-26x
BA649427	2-1	EC551160	3-C1	EL650193	8-108x	SK646817	9-14	ZW413188	8-62x
BA649440	5-1	EC551160	3-C10to15	EM664424	8-123	SK646828	9-16	ZW416698	8-42x
BA649451	4-1	EC551160	8-84x	EO539820	1-L4	SK646830	9-15	ZW420682	8-24x
BA649473	6-1	EC556018	1-C3	EO539820	8-151x	SK652397	8-12	ZW420682	8-25x
BA649473	8-161	EC556896	8-85x	EO650373	1-T3	SP645704	9-3	ZW465715	3-6
BA662984	3-2	EC590848	2-C5	EO650384	1-T1	SP645715	9-5	ZW526577	9-8
BA662995	3-3	EC621257	1-C51	EO650395	1-T2	SP645726	8-133x	ZW548010	9-12x
BA670735	1-2	EC622991	1-C7	EO650428	1-L2,3	SP645748	8-1	ZW562476	8-11x
BA670757	3-4	EC650114	8-69	EO650608	1-T4	SP645750	8-3x	ZW562476	8-148x
BA670768	3-5	EC650340	1-C9	EO650610	1-L1	SP647910	8-2x	ZW604416	8-27x
BA670814	7-1	EC650351	1-C10	ER428567	8-96x	SP664200	8-134x	ZW610492	8-120x
BA670814	8-63x	EC650406	1-C12	ER559034	8-95x	SP675145	8-4x	ZW610503	8-119x
BC679408	9-10	EC650417	1-C13	EE622978	2-R17,18	SP679432	9-4x	ZW646740	8-76x
BF649337	8-100	EC650417	1-C18	ER650430	1-FL1,2	SP679645	8-5x	ZW646751	8-70x
BT633025	1-T5	EC650417	1-C19	ER653556	8-94x	SZ645243	8-136x	ZW650643	8-48x
BT665774	8-60x	EC650463	1-C27	ER653578	3-R1	TA207347	8-78	ZW652408	8-14x
BT665796	8-59x	EC650474	1-C35	ES422436	8-6	TA378268	8-20x	ZW659147	8-127x
BT668294	8-58	EC650474	1-C39	ES624701	4-SW1	TA530910	8-17x	ZW659158	8-128x
BZ649304	9-1x	EC650485	1-C36	ES650171	8-98	TA541552	8-47	ZW659160	8-129x
BZ670713	9-2x	EC650485	1-C40	ES650182	8-93	TA605878	8-156x	ZW659171	8-130x
EC220127	3-C8	EC650496	1-C34	ES650283	1-SW1	TA605878	8-157x	ZW659182	8-131x
EC220364	2-C8	EC650496	1-C38	ES650305	1-SW2	TA616847	8-75x	ZW659193	8-132x
EC220432	1-C28	EC650520	5-C10	ES664244	1-SW1	TA625847	8-21x	ZW666180	8-53x
EC220432	1-C42,43	EC650698	2-C9	ES665875	8-86	TA641608	8-54		
EC220432	5-C6	EC650733	5-C2	ES672254	8-87x	TA645682	8-117		
EC220432	5-C13	EC650788	4-C1	ET342707	4-TR1	TA646367	8-124x		
EC290531	1-C4,5	EC650878	1-C44,45	ET459810	1-TR1,2	TA646378	8-73x		
EC290531	2-C3	EC654041	1-C19	ET459810	2-TR1	TA646503	8-154x		
EC290531	2-C6	EC658012	1-C18	ET459810	5-TR1,2	TA646514	8-67x		
EC320051	1-C23	EC658012	1-C68	ET557965	1-TR3	TA646525	8-68x		
EC320051	1-C33	EC664650	2-C12	ET618873	1-TR4	TA646536	8-50x		
EC320051	1-C60	EC666494	1-C49	ET635220	1-TR5	TA646547	8-51x		
EC321208	1-C48	EC675742	1-C66	ET635220	2-TR2	TA646571	8-89x		
EC321221	3-C2	EC675742	7-C1	ET635220	3-TR2	TA646582	8-81x		
EC324538	3-C5,6	EC684707	2-C11	ET649034	3-TR3	TA646593	8-101x		
EC329758	1-C6	ED224526	3-D1,2	ET650632	8-45	TA646648	6-2		
EC329771	1-C17	ED490511	2-D1	ET650654	2-TR3	TA646683	8-72x		
EC329771	1-C32	ED539976	3-D7	ET650665	2-TR4	TA646738	1-3		
EC329771	5-C12	ED624903	1-D1,2	ET655356	3-TR1	TA646762	8-113x		
EC329782	1-C15	ED630621	3-D3to6	EV465017	1-VR3	TA646773	8-116x		
EC331828	5-C9	ED650812	6-D1,2	EV484863	1-VR1	TA646784	8-126x		
EC336194	5-C1	EE562735	8-74	EV499364	1-VR2	TA646795	8-125		
EC350684	5-C3	EE650248	8-18	EV573366	2-VR2	TA646806	8-135x		
EC357827	2-C7	EE664233	8-19x	EV593368	2-VR1	TA646852	8-55x		
EC368256	1-C8	EF277402	8-144x	EV650700	5-VR2	TA646863	8-57		
EC368256	1-C52	EF277413	8-140x	EV650711	5-VR1	TA646874	3-9		
EC379157	5-C7,8	EF487438	8-146x	EV650722	5-VR3,4	TA646896	8-80x		
EC379833	4-C2	EF593706	8-143x	EW374894	8-33	TA648314	8-121		
EC405044	2-C2	EF602550	8-141x	EW516600	8-34x	TA675123	8-118x		
EC427228	1-C14	EF623114	8-145x	EW516600	8-35x	TC494267	8-79x		
EC427228	1-C16	EF659711	8-147x	EZ246936	8-29x	ZS325495	3-10		
EC427228	1-C20to22	EF666191	8-142x	EZ246936	8-37x	ZS325495	8-43		
EC427228	1-C25,26	EI650362	1-IC1	EZ610773	8-109x	ZS325495	9-9x		
EC427228	1-C30	EI650586	1-IC2	EZ624047	8-97x	ZS380046	8-49x		
EC427228	1-C57,58	EI650597	1-IC3	EZ624734	8-46x	ZS406416	8-90x		
EC427228	1-C61	EJ205986	8-150x	EZ646626	8-122x	ZS417150	8-41x		
EC428995	7-C2	EJ254957	8-138x	EZ646885	8-44	ZS421740	8-9x		
EC450055	1-C2	EJ299316	8-15	EZ655187	8-8	ZS421806	3-8		
EC450055	1-C31	EJ539447	8-66x	EZ655198	8-110x	ZS422076	1-4		
EC450055	1-C46	EJ539447	8-139x	EZ665785	8-111x	ZS422076	6-3		
EC450055	1-C62	EJ539662	1-7	EZ665820	8-112x	ZS422076	8-71x		
EC450055	5-C4	EJ539662	1-8	MB650147	8-82x	ZS432674	8-99x		
EC450527	1-C29	EJ539662	2-2	MB650147	8-104x	ZS447761	8-16		
EC455354	1-C1	EJ539662	3-11	MI650136	8-77	ZS447840	8-52x		
EC469708	1-C67	EJ539662	4-2	ML668823	8-65x	ZS510344	9-13		
EC474671	5-C11	EJ539662	5-2	MR530651	8-102	ZS530673	8-103x		
EC485111	1-C65	EJ539662	7-2	MR530662	8-107	ZS552600	8-22x		
EC487394	2-C10	EJ551035	8-64x	MZ229138	8-152x	ZS608185	8-7x		
EC516723	1-C11	EJ631945	8-28	MZ229138	8-153x	ZS675382	8-13x		
EC522167	1-C50	EJ631945	8-36x	MZ646492	8-56x	ZW260122	8-115x		
EC523293	1-C64	EJ631945	8-38x	MZ646558	8-88x	ZW270123	8-114x		
EC539943	2-C1	EJ634915	8-91	MZ656807	1-6	ZW270191	8-92x		
EC539943	2-C4	EJ645928	8-149	MZ659777	9-7x	ZW273756	3-7		
EC551215	3-C4	EJ650250	8-30	MZ664211	8-106x	ZW273756	8-10x		
EC551441	1-C24	EJ650261	8-32	SE569744	8-158x	ZW273756	8-31x		
EC551441	1-C54	EJ650272	1-5	SE569744	8-159x	ZW273881	8-39x		
EC551441	1-C59	EJ650272	8-160	SE613888	9-6	ZW273892	8-40x		
EC551441	3-C3	EJ665818	8-155x	SE641597	9-11	ZW273914	8-23x		

AA-1020

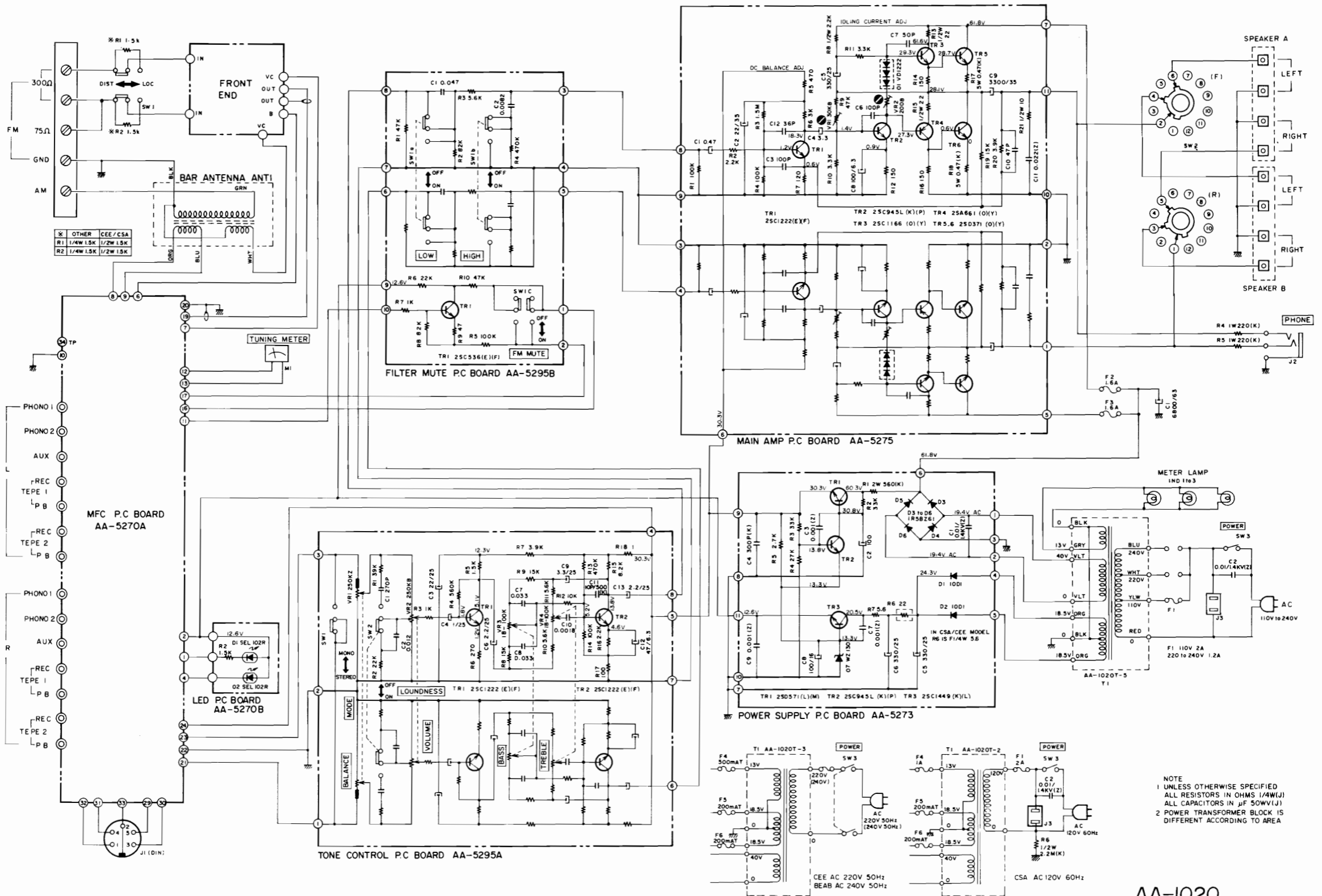

NOTE
 1 UNLESS OTHERWISE SPECIFIED
 ALL RESISTORS IN OHMS 1/4W(J)
 ALL CAPACITORS IN μF 50WV(J)
 2 POWER TRANSFORMER BLOCK IS
 DIFFERENT ACCORDING TO AREA

AA-1020
 SCHEMATIC DIAGRAM
 NO. 4-1 1520226A

AA-1020L

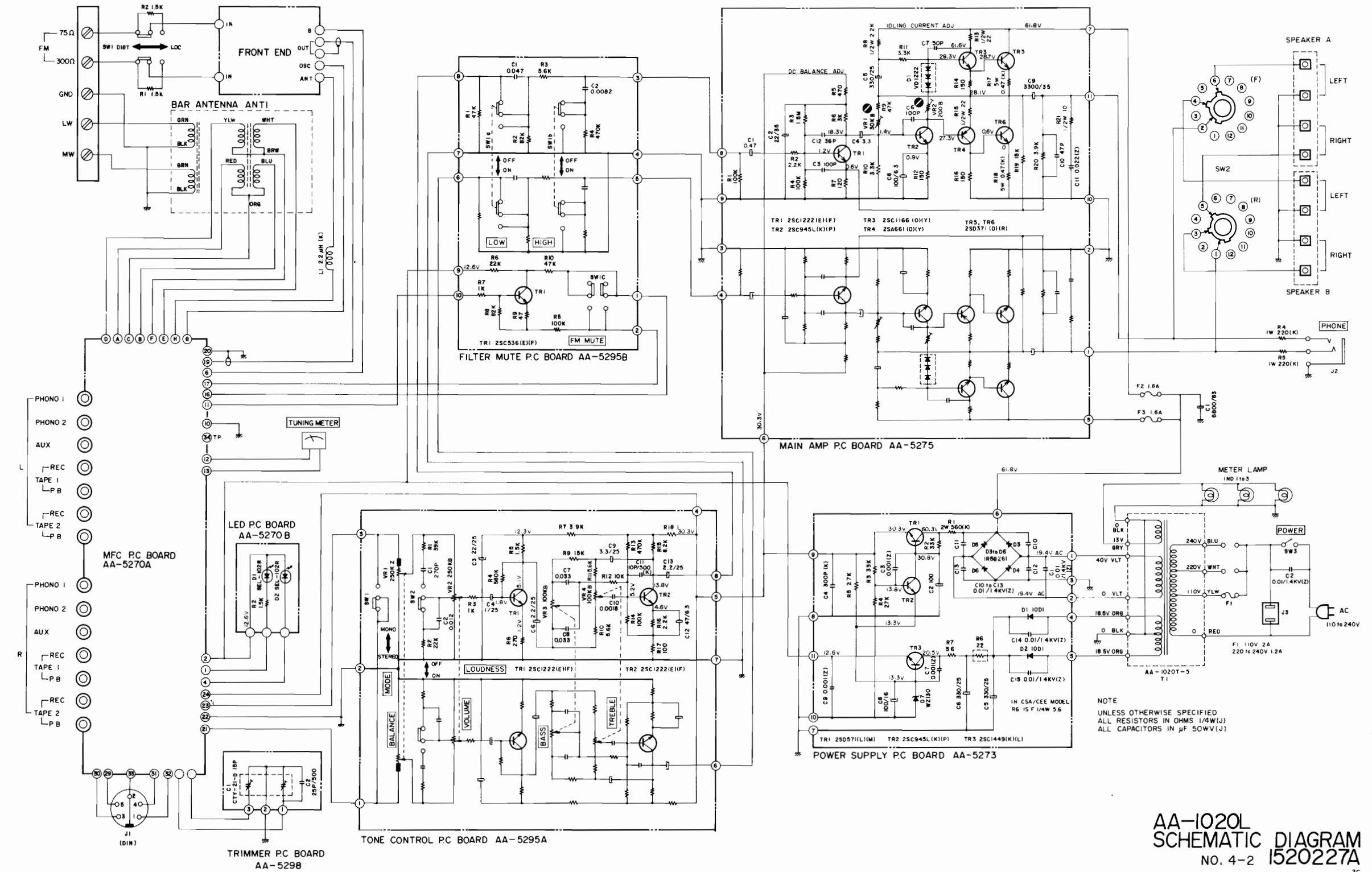

AA-1020L
SCHEMATIC DIAGRAM
NO. 4-2 1520227A

AA-1020

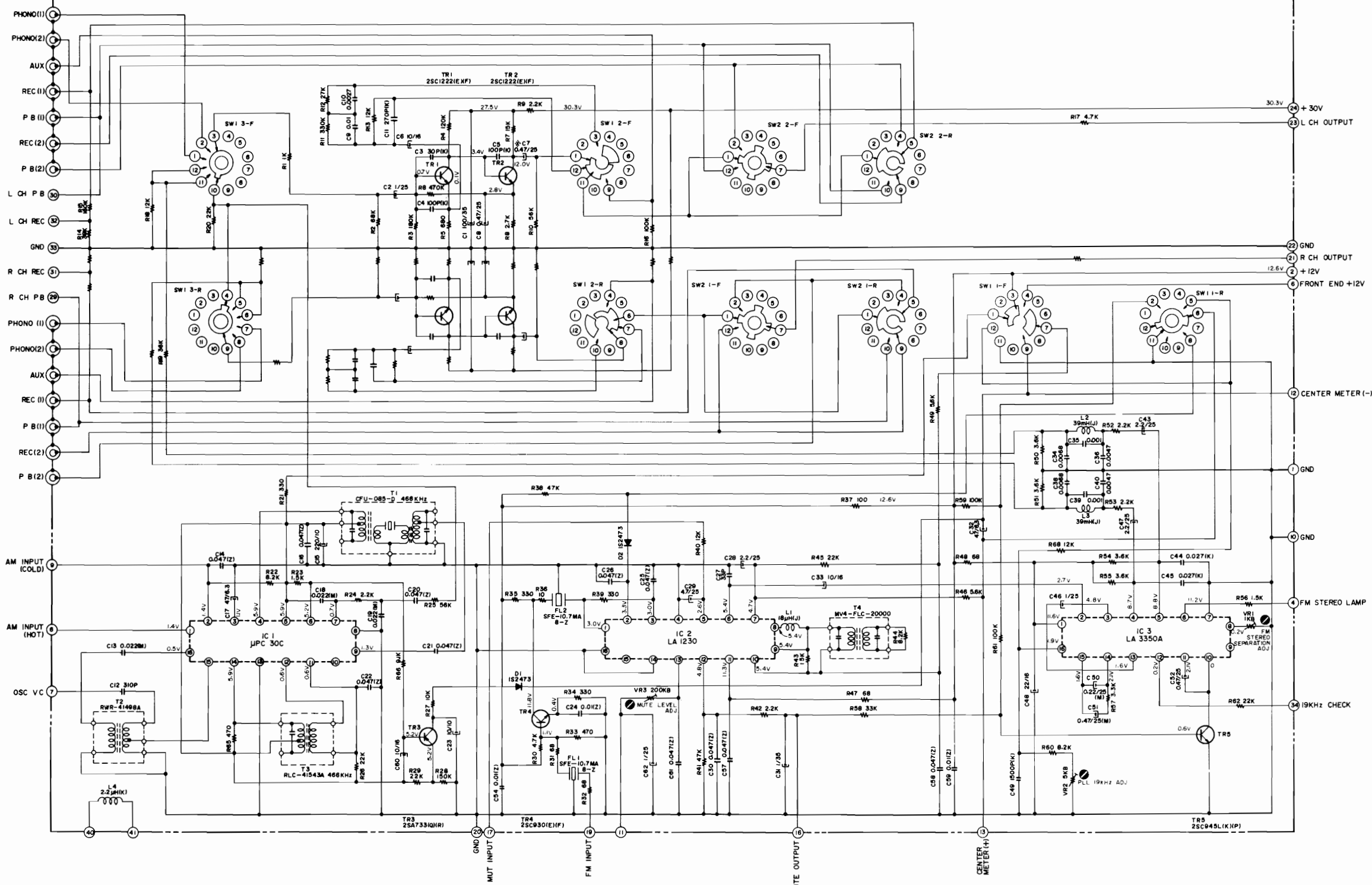

SWITCH POSITIONS

SW 1 (SELECTOR)	SW 2 (TAPE)
① AM	① 1-2
② FM MONO	② 1
③ FM AUTO	③ SOURCE
④ PHONO 1	④ 2
⑤ PHONO 2	⑤ 2-1
⑥ AUX	

NOTE
 1. UNLESS OTHERWISE SPECIFIED
 ALL RESISTORS IN OHMS 1/4W(U)
 ALL CAPACITORS IN μF 50WV(U)
 2. *MARK INDICATES LOW LEAKAGE CAPACITORS

AA-1020
 SCHEMATIC DIAGRAM
 NO.4-3 1520228A

AA-1020L

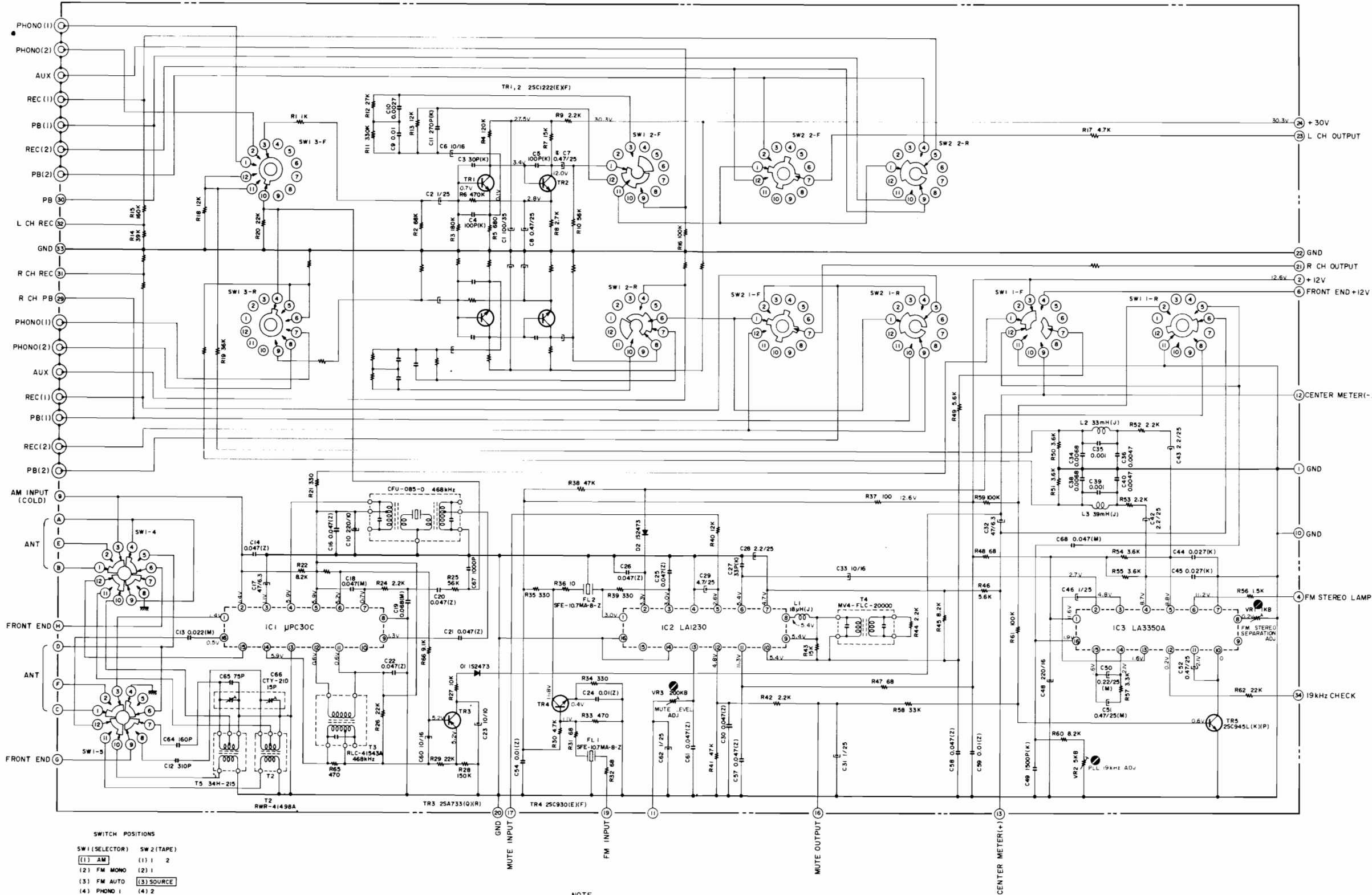

SWITCH POSITIONS

SW 1 (SELECTOR)	SW 2 (TAPE)
(1) AM	(1) 1 2
(2) FM MONO	(2) 1
(3) FM AUTO	(3) SOURCE
(4) PHONO 1	(4) 2
(5) PHONO 2	(5) 2 1
(6) AUX	

NOTE
 1. UNLESS OTHERWISE SPECIFIED
 ALL RESISTORS OHMS (1/4W (J))
 ALL CAPACITORS IN µF 50WV (J)
 2. X MARK INDICATES LOW LEAKAGE CAPACITORS

AA-1020L
 SCHEMATIC DIAGRAM
 NO. 4-4 1520229A